

Features

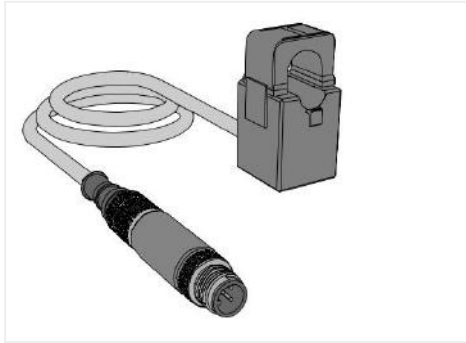

- Connects to the included current transformer and outputs the value to Modbus registers
- Monitors AC current for various devices using current transformers
- Converts a high-voltage input to a proportional low-voltage, low-current signal for measuring and monitoring
- Meets IP65, IP67, and IP68 ratings with a rugged overmolded housing



S15C-CT Models

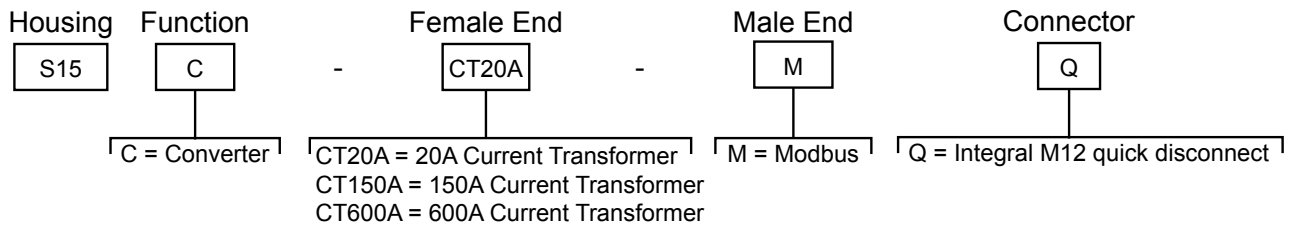

Split-core current transformers are used to monitor AC current for various devices. The current transformer input takes a high voltage current input and produces a proportional low-voltage, low-current signal for measuring and monitoring. Split-core current transformers are ideal for installing onto existing electrical wiring because they can snap around the individual conductors without having to disconnect any cables.

NOTE: Users can use any size current transformer rated up to a 655 A max rating, as long as the current transformer has a 333 mV AC output.

Installing the Current Transformers

Observe the polarity when installing current transformers. Banner's current transformers indicate **k** as the source side and **l** as the load side, where source refers to the incoming power feed side to the device and the load side is the device side.

Banner's CTs have an etched arrow to indicate the directionality for installation (k -> l). As shown in ["Installing a current transformer relative to the power supply/motor" on page 2](#), the source is the AC power supply and the load is the Motor. The CT direction arrow must point toward the load. Banner's current transformers can be installed on any conductor in a 2- or 3-phase AC line. Current transformers should only be installed on a single conductor. For the correct installation, see ["Installing a single conductor on the current transformer" on page 2](#).



Installing a current transformer relative to the power supply/motor

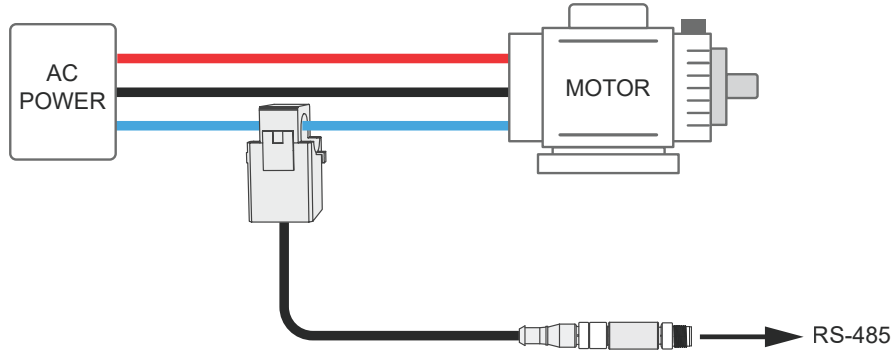

Installing a single conductor on the current transformer

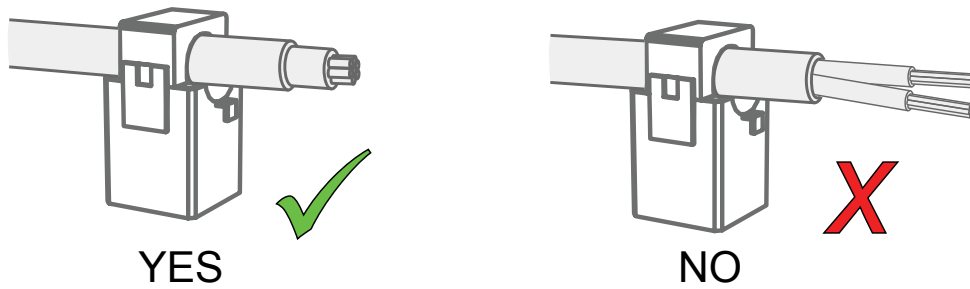

Wire the Current Transformer

For more information on wiring and installing the current transformer, refer to the Split Core Current Transformer datasheet (p/n [212463](#)).

Current transformer wiring

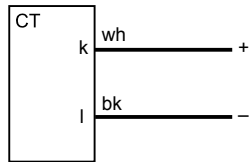

Wire Color	Description
White	Input from CT (k)
Black	CT ground (l)

Converter Wiring

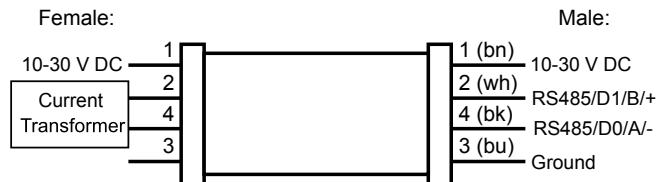

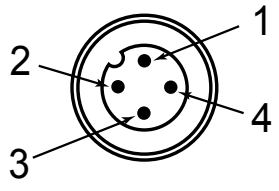
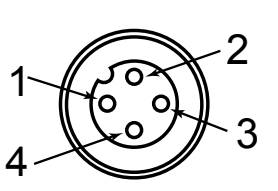
Male (Gateway)	Female (Sensor)	Pin	Wire Color
		1	Brown
		2	White
		3	Blue
		4	Black

Female (Sensor)	Signal Description
Pin 1	10 V DC to 30 V DC
Pin 2	CT Input
Pin 3	Not Used
Pin 4	CT Ground

Male (Gateway)	Signal Description
Pin 1	10 V DC to 30 V DC
Pin 2	RS485/D1/B/+
Pin 3	Ground
Pin 4	RS485/D0/A/-

Configuration Instructions

Sensor Configuration Software

The Sensor Configuration Software offers an easy way to manage converter Modbus settings, retrieve data, and visually show converter data. The Sensor Configuration Software runs on any Windows machine and uses an adapter cable (BWA-UCT-900, p/n 19970) to connect the converter to the computer.

Download the most recent version of the Sensor Configuration Software from the Banner Engineering website: https://info.bannerengineering.com/cs/groups/public/documents/software/b_3128586.exe.

S15C-CT Modbus Configuration

Modbus Register Address	Type	Name	I/O Range	Description	Notes	Default ⁽¹⁾
IO Data Out						
40001	uint16, Read Only	IO Data	0-65535	Analog Data output	AC RMS Current (A) = Register Value/100	0-2000, 0-15000, or 0-60000
40002	bool, Read Only	IO Alarm State	-	Alarm State for IO based on Min and Max thresholds defined in Analog In Min Value () and Analog In Max Value ()	0 = Within threshold range 1 = Out of threshold range	-
40003	int16, Read Only	IO Error Status	STATUS_ERROR_TYPE_NO_ERROR = 0 STATUS_ERROR_TYPE_BELOW_MIN = 1 STATUS_ERROR_TYPE_ABOVE_MAX = 2	Status of program	0-2 value	-
IO Data Rate						
41201	uint16, Read and Write	Sample IO	0-65535	Sample interval time for IO	Increments of 62.5 ms	16 (1 second)
Minimum Value						
41204	uint16, Read and Write	Minimum Analog Value	-	Minimum analog value for data read	Minimum value: 0	0
Maximum Value						
41205	uint16, Read and Write	Maximum Analog Value	-	Max analog value for data read	Maximum value	20, 150, or 600
CT Type Input						

Continued on page 4

⁽¹⁾ Based on the model selected

Continued from page 3

Modbus Register Address	Type	Name	I/O Range	Description	Notes	Default
41011	int16, Read and Write	AC Line Frequency	1 = 60 Hz 2 = 50 Hz	AC Line Frequency	1 = 60 Hz 2 = 50 Hz	1
41015	uint16, Read and Write	CT Amp value	0-655	Amp value of the transformer used User-defined: 0-655	-	20, 150, or 600
COMs Settings						
46101	Baud Rate	-	0 = 9.6k 1 = 19.2k 2 = 38.4k	-	-	1
46102	Parity	-	0 = None 1 = Odd 2 = Even	-	-	0
46103	Modbus Slave Address	-	1 to 247	-	-	1

Status Indicators

Power LED Indicator (Green)

- Solid Green = Power On
- Off = Power Off

Modbus Communication LED Indicator (Amber)

- Flashing Amber (4 Hz) = Modbus communications are active
- Solid Amber for 2 seconds to Off = Modbus communications are lost after connection
- Solid Amber for 2 seconds to Flashing Amber (4 Hz) = Modbus communications momentarily lost, but communication reestablished
- Solid Amber = Modbus communications are intermittent, or communications error occurs more frequently than once every 2 seconds
- Off = Modbus communications are not present

S15C-CT Specifications

Supply Voltage

10 V DC to 30 V DC at 50 mA maximum

Power Pass-Through Current

4 A maximum

Supply Protection Circuitry

Protected against reverse polarity and transient voltages

Leakage Current Immunity

400 μ A

Resolution

12-bits

Current Transformer

Electrical:

Rated Input: 0-20 A (CT20A), 0-150 A (CT150A), or 0-600

A (CT600A), depending on the model

Rated Output: 0.333 V AC

Ratio: $\leq \pm 1.0\%$

Phase Angle: $\leq \pm 60$ min

Dielectric Strength: 2.5 kV/1 mA/1 min

Insulation Resistance: DC 500 V/100 M Ω min

Mechanical:

Case: PA / UL94-V0

Bobbin: PBT

Core: Silicon Steel

-25 °C to +75 °C (-13 °F to +167 °F)

$\leq 85\%$ maximum relative humidity (non-condensing)

For more information, refer to the Split Core Current Transformer datasheet (p/n 212463)

Indicators

Green power

Amber Modbus communications

Connections

Integral male/female 4-pin M12 quick disconnect

Construction

Coupling Material: Nickel-plated brass

Connector Body: PVC translucent black

Vibration and Mechanical Shock

Meets IEC 60068-2-6 requirements (Vibration: 10 Hz to 55 Hz, 0.5 mm amplitude, 5 minutes sweep, 30 minutes dwell)

Meets IEC 60068-2-27 requirements (Shock: 15G 11 ms duration, half sine wave)

Environmental Rating

IP65, IP67, IP68

NEMA/UL Type 1

Operating Conditions

Temperature: -40 °C to +70 °C (-40 °F to +158 °F)

90% at +70 °C maximum relative humidity (non-condensing)

Storage Temperature: -40 °C to +80 °C (-40 °F to +176 °F)

Required Overcurrent Protection



WARNING: Electrical connections must be made by qualified personnel in accordance with local and national electrical codes and regulations.

Overcurrent protection is required to be provided by end product application per the supplied table.

Overcurrent protection may be provided with external fusing or via Current Limiting, Class 2 Power Supply.

Supply wiring leads < 24 AWG shall not be spliced.

For additional product support, go to www.bannerengineering.com.

Supply Wiring (AWG)	Required Overcurrent Protection (A)	Supply Wiring (AWG)	Required Overcurrent Protection (A)
20	5.0	26	1.0
22	3.0	28	0.8
24	1.0	30	0.5

Certifications



Banner Engineering BV
Park Lane, Culliganlaan 2F bus 3
1831 Diegem, BELGIUM



Turck Banner LTD Blenheim House
Blenheim Court
Wickford, Essex SS11 8YT
GREAT BRITAIN



FCC Part 15 Class A

This equipment has been tested and found to comply with the limits for a Class A digital device, pursuant to part 15 of the FCC Rules. These limits are designed to provide reasonable protection against harmful interference when the equipment is operated in a commercial environment. This equipment generates, uses, and can radiate radio frequency energy and, if not installed and used in accordance with the instruction manual, may cause harmful interference to radio communications. Operation of this equipment in a residential area is likely to cause harmful interference in which case the user will be required to correct the interference at his own expense.

Industry Canada

This device complies with CAN ICES-3 (B)/NMB-3(B). Operation is subject to the following two conditions: 1) This device may not cause harmful interference; and 2) This device must accept any interference received, including interference that may cause undesired operation.

Cet appareil est conforme à la norme NMB-3(B). Le fonctionnement est soumis aux deux conditions suivantes : (1) ce dispositif ne peut pas occasionner d'interférences, et (2) il doit tolérer toute interférence, y compris celles susceptibles de provoquer un fonctionnement non souhaité du dispositif.

Current Transformer Dimensions

All measurements are listed in millimeters [inches], unless noted otherwise.

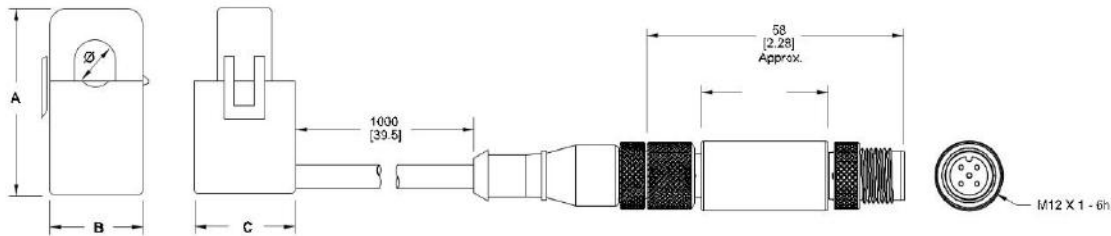

Model	Diameter	A	B	C
CT20A	10 mm (0.39 in)	41 mm (1.61 in)	24 mm (0.94 in)	26.5 mm (1.04 in)
CT150A	16 mm (0.63 in)	45.5 mm (1.79 in)	29 (1.14 in)	31.5 mm (1.24 in)
CT600A	35.7 mm (1.41 in)	92.9 mm (3.66 in)	65.25 mm (2.57 in)	42 mm (1.65 in)

Accessories

Cordsets

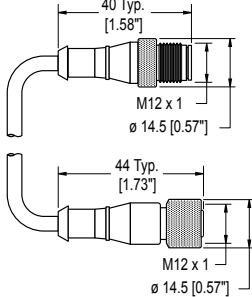
4-Pin Threaded M12 Cordsets—Double Ended				
Model	Length	Style	Dimensions	Pinout
MQDEC-401SS	0.31 m (1 ft)	Male Straight/Female Straight		Female
MQDEC-403SS	0.91 m (2.99 ft)			Female
MQDEC-406SS	1.83 m (6 ft)			Female
MQDEC-412SS	3.66 m (12 ft)			Female
MQDEC-420SS	6.10 m (20 ft)			Female
MQDEC-430SS	9.14 m (30.2 ft)			Female
MQDEC-450SS	15.2 m (49.9 ft)			Male

1 = Brown
 2 = White
 3 = Blue
 4 = Black

Banner Engineering Corp Limited Warranty

Banner Engineering Corp. warrants its products to be free from defects in material and workmanship for one year following the date of shipment. Banner Engineering Corp. will repair or replace, free of charge, any product of its manufacture which, at the time it is returned to the factory, is found to have been defective during the warranty period. This warranty does not cover damage or liability for misuse, abuse, or the improper application or installation of the Banner product.

THIS LIMITED WARRANTY IS EXCLUSIVE AND IN LIEU OF ALL OTHER WARRANTIES WHETHER EXPRESS OR IMPLIED (INCLUDING, WITHOUT LIMITATION, ANY WARRANTY OF MERCHANTABILITY OR FITNESS FOR A PARTICULAR PURPOSE), AND WHETHER ARISING UNDER COURSE OF PERFORMANCE, COURSE OF DEALING OR TRADE USAGE.

This Warranty is exclusive and limited to repair or, at the discretion of Banner Engineering Corp., replacement. **IN NO EVENT SHALL BANNER ENGINEERING CORP. BE LIABLE TO BUYER OR ANY OTHER PERSON OR ENTITY FOR ANY EXTRA COSTS, EXPENSES, LOSSES, LOSS OF PROFITS, OR ANY INCIDENTAL, CONSEQUENTIAL OR SPECIAL DAMAGES RESULTING FROM ANY PRODUCT DEFECT OR FROM THE USE OR INABILITY TO USE THE PRODUCT, WHETHER ARISING IN CONTRACT OR WARRANTY, STATUTE, TORT, STRICT LIABILITY, NEGLIGENCE, OR OTHERWISE.**

Banner Engineering Corp. reserves the right to change, modify or improve the design of the product without assuming any obligations or liabilities relating to any product previously manufactured by Banner Engineering Corp. Any misuse, abuse, or improper application or installation of this product or use of the product for personal protection applications when the product is identified as not intended for such purposes will void the product warranty. Any modifications to this product without prior express approval by Banner Engineering Corp will void the product warranties. All specifications published in this document are subject to change; Banner reserves the right to modify product specifications or update documentation at any time. Specifications and product information in English supersede that which is provided in any other language. For the most recent version of any documentation, refer to: www.bannerengineering.com.

For patent information, see www.bannerengineering.com/patents.