

Magnetic inductive flow sensors // VMZ.2 induQ®

US version available

Note: The US versions are separate products.
The units are not converted, but pre-configured at the factory for the respective variants.



Product features

- Repeatability $\leq 1\%$ of reading
→ Reassures process reliability
- (1) Free cross section
→ Very low pressure drop
- (2) Works independent from position
- No moving parts
→ No wear, insensitive to particles
- Six nominal diameters available
- Hastelloy® option available
→ Suitable for corrosive liquids
- Insensitive to changes of viscosity
→ Consistent accuracy
- High sampling rate
→ Works for oscillation flow
- Delivery includes works calibration certificate

Medium



Measuring pipe PVDF:
-15...80 °C (non-freezing)
5...176 °F (non-freezing)

Measuring pipe POM:
-15...60 °C (non-freezing)
5...140 °F (non-freezing)

Works calibration certificate

- Traceable by serial number
- 100% final testing in a water test bench
- 6 points calibration

1



2



Markets/Applications:

- **General Engineering:**
Measuring of cooling water, measuring of waste water, dosing of mold release agents
- **Cleaning Industry:**
Dosing of detergents and other additives
- **Concrete Production:**
Dosing of agents and colours
- **Agriculture and Livestock:**
Dosing of water, fertilizer, fungicides and pesticides, measuring of water and liquid feed supplements
- **Exhaust Gas Cleaning:**
Dosing of AdBlue

Highlights

- Cost optimised plastic version
- Compact lightweight construction
- Particularly suitable for series applications
- Best price-performance ratio

Technical data

Type	VMZ03	VMZ06	VMZ08	VMZ15	VMZ20	VMZ25
Technical data						
Nominal diameter	DN 3	DN 6	DN 8	DN 15	DN 20	DN 25
Nominal pipe size	1/16"	1/4"	1/4"	1/2"	3/4"	1"
Process connection [male thread]	G3/8	G1/2	G1/2	G3/4	G 1	G 1 1/4
Process connection [male thread]	3/8" NPT	1/2" NPT	1/2" NPT	3/4" NPT	1" NPT	1 1/4" NPT
Inner diameter [mm]	3	6	8	14	18	25
Inner diameter [inch]	0.118	0.31	0.31	0.55	0.71	0.98
Flow range [l/min]	0.1...2	0.25...5	1...20	2.5...50	5...200	12.5...250
Flow range [US gpm]	0.026...0.53	0.066...1.3	0.26...5.3	0.66...13.2	1.3...53	3.3...66
Accuracy*	±0.7 % of reading ±0.3 % of range					
Repeatability	±1 %					
Response time	<100 ms					
Signal output starting from [l/min]	0.05	0.1	0.25	1	4	5
Signal output starting from [US gpm]	0.013	0.026	0.07	0.27	1.06	1.32
Max. Flow rate [l/min]	2.5	6	25	60	240	300
Max. Flow rate [US gpm]	0.66	1.58	6.6	15.8	63.4	79.2
Medium / min. conductivity of medium	Water and other conductive liquids / 20 µS/cm					
Medium temperature → Measuring pipe PVDF → Measuring pipe POM	-15...80 °C (non-freezing) -15...60 °C (non-freezing)					
Medium temperature → Measuring pipe PVDF → Measuring pipe POM	5...176 °F (non-freezing) 5...140 °F (non-freezing)					
Ambient temperature	-15...60 °C					
Ambient temperature	5...140 °F					
Storage temperature	-15...60 °C					
Storage temperature	5...140 °F					
Max. pressure rating	10 bar at 20 °C, 8 bar at 40 °C, 6 bar at 60 °C, 5 bar at 80 °C					
Max. pressure rating	145 psi at 68 °F, 116 psi at 104 °F, 87 psi at 140 °F, 73 psi at 176 °F					
Indications	LED green, flow proportional flashing					
Degree of protection EN 60529	IP65 (with attached cable socket)					
Electrical data						
Electrical connection	4 pin plug connector M12 x 1					
Power supply	12...24 VDC (±10 %) (With analog output 0.5...10 V: 16...24 VDC (±10 %))					
Power consumption	Typical 1.1 W, max. 3.6 W					
Electrical protection measures	Short-circuit proof and polarity protection					

* Test conditions: Ex works, water 23 °C (73 °F)

Output signals

Six different versions available:

- Frequency output
- Frequency output and analogue output 4...20 mA
- Frequency output and analogue output 0.5...10 V and frequency output (Only available with power supply 16...24 VDC)
- Pulse output
- Pulse output and analogue output 4...20 mA
- Pulse output and analogue output 0.5...10 V and frequency output (Only available with power supply 16...24 VDC)

Frequency output	VMZ03	VMZ06	VMZ08	VMZ15	VMZ20	VMZ25
Pulse rate [pulses/l]*	10 000	4000	1000	400	200	80
Pulse rate [pulses/gallon]*	30 000	15 000	3000	1500	750	300
Resolution [ml/pulse]*	0.1	0.25	1	2.5	5	12.5
Signal shape	Square wave signal, pulse duty ratio 50:50, Push-Pull NPN open collector PNP open collector					
Signal current	Max. 100 mA					

Pulse output	VMZ03	VMZ06	VMZ08	VMZ15	VMZ20	VMZ25
Pulse rate [pulses/l]*	10 000	4000	1000	400	200	80
Pulse rate [pulses/gallon]*	30 000	15 000	3000	1500	750	300
Resolution [ml/pulse]*	0.1	0.25	1	2.5	5	12.5
Signal shape	Square wave signal, pulse duty ratio 50:50, Push-Pull NPN open collector PNP open collector					
Signal current	Max. 100 mA					

Analogue output 4...20 mA	VMZ03	VMZ06	VMZ08	VMZ15	VMZ20	VMZ25
Corresponds to flow rate [l/min]**	0...2	0...5	0..20	0...50	0...200	0...250
Corresponds to flow rate [US gpm]**	0...0.53	0...1.3	0...5.3	0...13.2	0...53	0...66
Max. burden	250 Ω against GND					

Analogue output 0.5...10 V	VMZ03	VMZ06	VMZ08	VMZ15	VMZ20	VMZ25
Corresponds to flow rate [l/min]**	0...2	0...5	0..20	0...50	0...200	0...250
Corresponds to flow rate [US gpm]**	0...0.53	0...1.3	0...5.3	0...13.2	0...53	0...66

* Other pulse rates/resolutions available on request, optional: output signal with lower frequency, designed specifically for connection to digital PLC inputs

** Other ranges available on request

Typical pressure drop

Typical pressure drop VMZ03

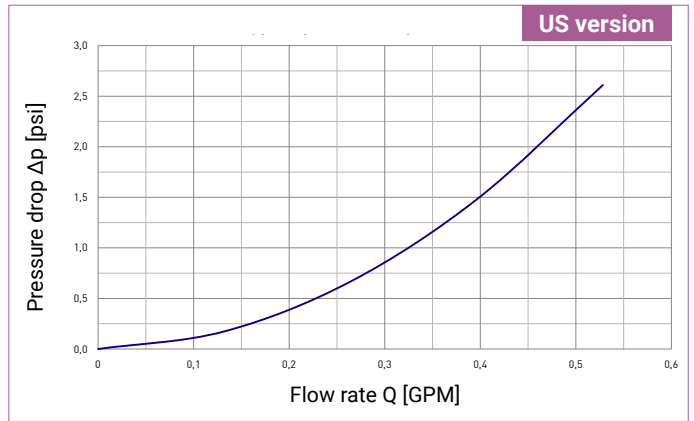
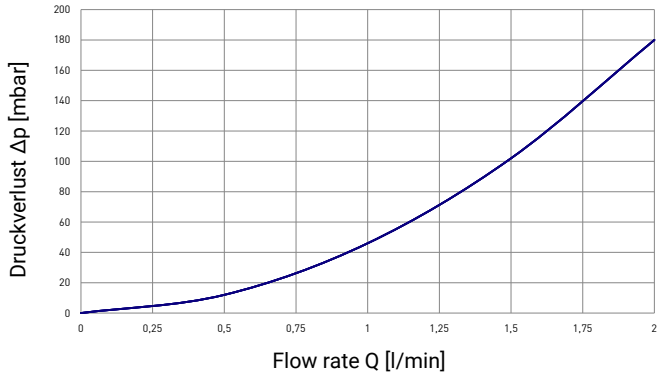

Typical pressure drop VMZ06

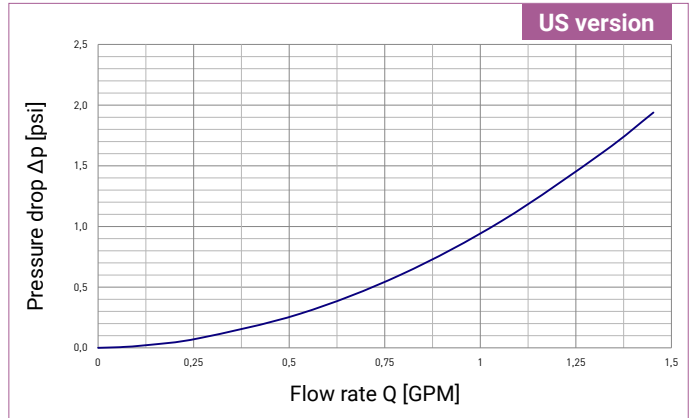
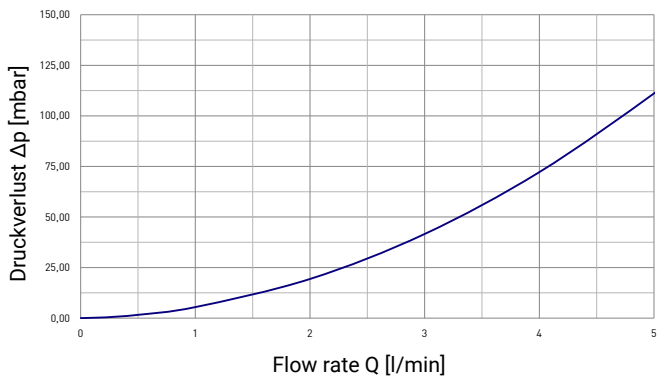

Typical pressure drop VMZ08

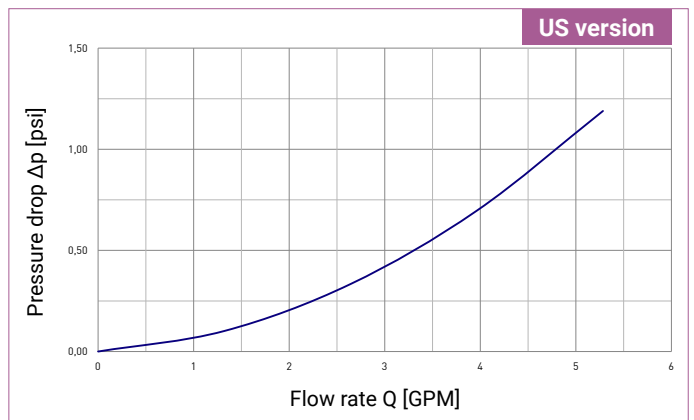
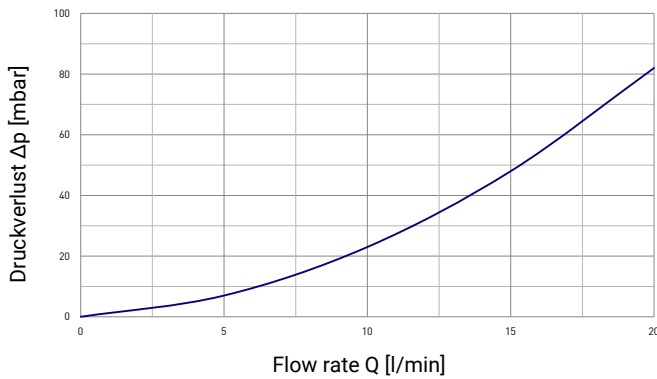

Typical pressure drop

Typical pressure drop VMZ15

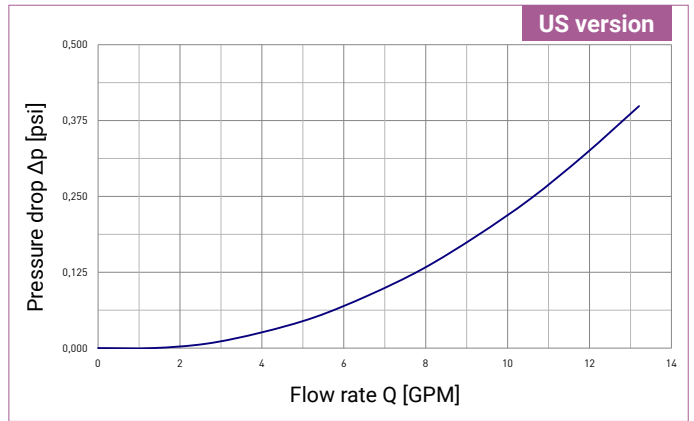
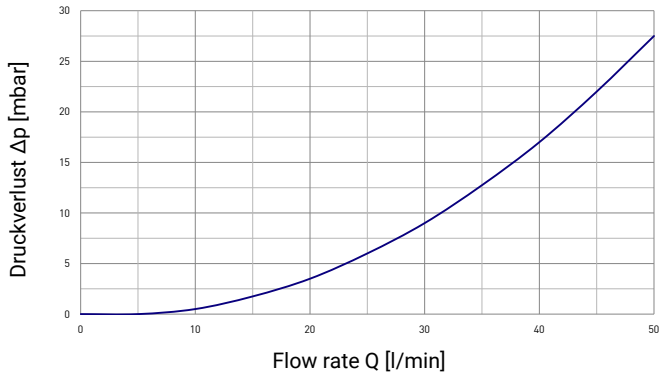

Typical pressure drop VMZ20

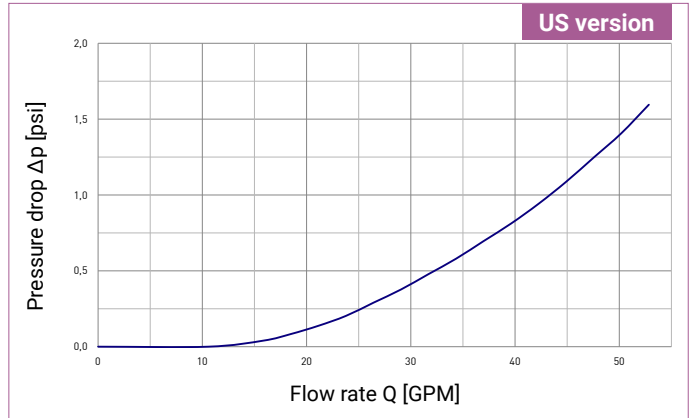
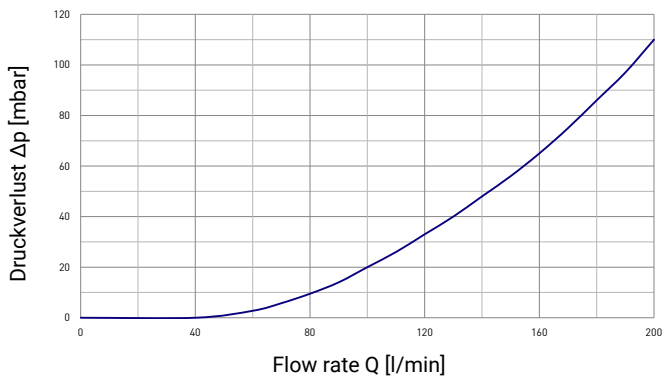

Typical pressure drop VMZ25

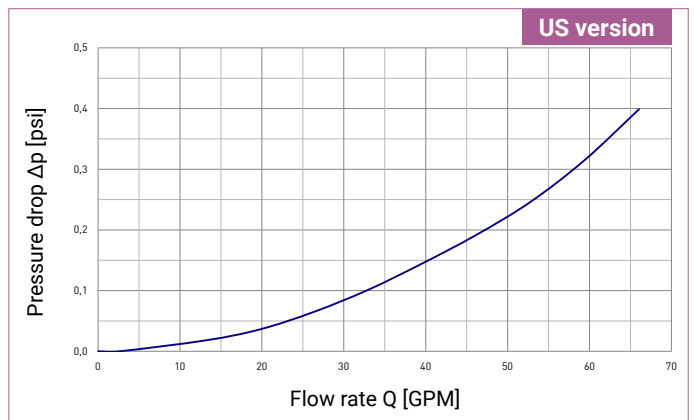
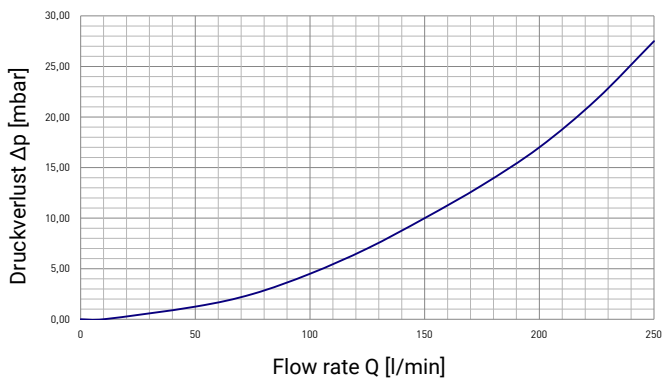

Technical drawings

VMZ03 / VMZ06/ VMZ08 / VMZ15 / VMZ20

VMZ25

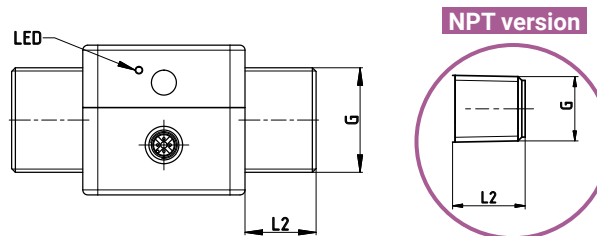
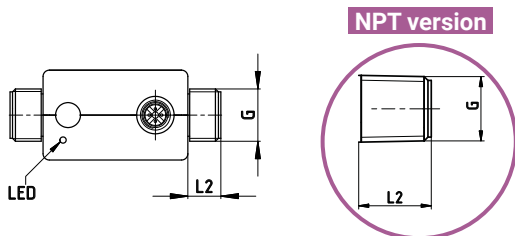
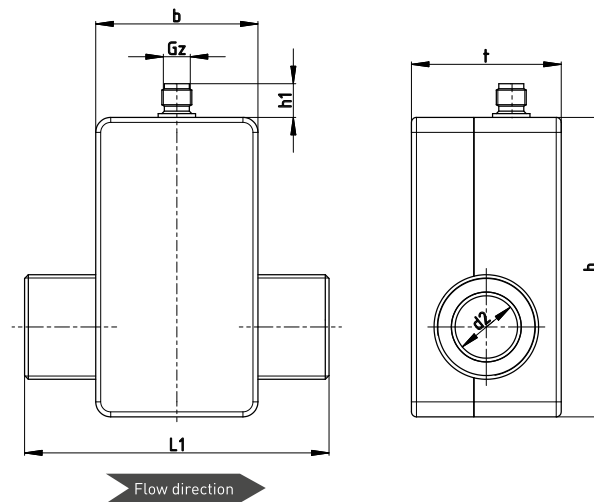
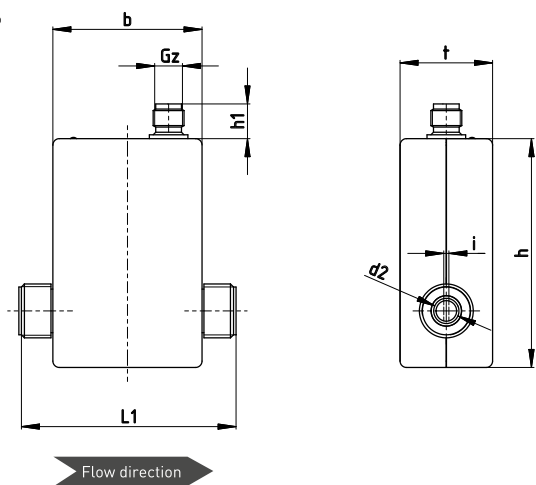

Dimensions

Dimensions [mm]										
Type	L1	L2	G	d2	b	Gz	h	h1	t	i
VMZ03	85	13	G $\frac{3}{8}$ B	Ø 3	58	M12 x 1	89	13.5	36	
VMZ06	85	13	G $\frac{1}{2}$ B	Ø 8	58	M12 x 1	89	13.5	36	2
VMZ08	85	13	G $\frac{1}{2}$ B	Ø 8	58	M12 x 1	89	13.5	36	
VMZ15	90	16	G $\frac{3}{4}$ B	Ø 14	58	M12 x 1	89	13.5	36	
VMZ20	90	16	G1 B	Ø 18	58	M12 x 1	89	13.5	36	
VMZ25	122	28,5	G1 $\frac{1}{4}$ B	Ø 25	65	M12 x 1	120	13.5	60	
Dimensions [inch]										
VMZ03	3.68	0.67	$\frac{3}{8}$ - 18 NPT	Ø 0.118	2.28	M12 x 1	3.5	0.53	1.42	
VMZ06	4	0.83	$\frac{1}{2}$ - 14 NPT	Ø 0.315	2.28	M12 x 1	3.5	0.53	1.42	0.08
VMZ08	4	0.83	$\frac{1}{2}$ - 14 NPT	Ø 0.315	2.28	M12 x 1	3.5	0.53	1.42	
VMZ15	4.02	0.83	$\frac{3}{4}$ - 14 NPT	Ø 0.551	2.28	M12 x 1	3.5	0.53	1.42	
VMZ20	4.41	1.02	1 - 11.5 NPT	Ø 0.708	2.28	M12 x 1	3.5	0.53	1.42	
VMZ25	4.8	1.04	1 $\frac{1}{4}$ - 11.5 NPT	Ø 0.984	2.56	M12 x 1	4.72	0.53	2.36	

Materials

Materials		
Not in contact with fluid	G thread	NPT thread
Housing	ABS	
In contact with fluid		
Electrodes and earthing rings	Stainless steel 1.4404 or Hastelloy C®	
Measuring pipe and process connections	POM or PVDF	PVDF (POM on request)
O-rings	EPDM or FKM for version with Hastelloy C®	

Article numbers

Order code				
Flow range				
0.1...2 l/min	VMZ032S1			4000
0.25...5 l/min	VMZ063S1			4000
1...20 l/min	VMZ083S1			4000
2.5...50 l/min	VMZ154S1			4000
5...200 l/min	VMZ205S1			4000
12.5...250 l/min	VMZ256S2			4000
Measuring pipe and electrode materials				
POM, electrodes and earthing rings made of stainless steel 1.4404		DE		
PVDF, electrodes and earthing rings made of stainless steel 1.4404		PE		
POM, Electrodes and earthing rings made of Hastelloy C®		DB		
PVDF, Electrodes and earthing rings made of Hastelloy C®		PB		
Output signal				
Frequency signal (Push-Pull)			GY	
Frequency signal (Push-Pull) and Analogue signal 4...20 mA			AY	
Frequency signal (Push-Pull) and Analogue signal 0.5...10 V			VZ	
Pulse signal (Push-Pull)			DY	
Pulse signal (Push-Pull) and Analogue signal 4...20 mA			IY	
Pulse signal (Push-Pull) and Analogue signal 0.5...10 V			UZ	
Example order number	VMZ032S1	PE	GY	4000

Order code [US version]				
Flow range				
0.026...0.53 US gpm	VMZ03BS1			400A
0.066...1.3 US gpm	VMZ06CS1			400A
0.26...5.3 US gpm	VMZ08CS1			400A
0.66...13.2 US gpm	VMZ15DS1			400A
1.3...53 US gpm	VMZ20ES1			400A
3.3...66 US gpm	VMZ25FS2			400A
Measuring pipe and electrode materials				
PVDF, electrodes and earthing rings made of stainless steel 1.4404		PE		
PVDF, Electrodes and earthing rings made of Hastelloy C®		PB		
Output signal				
Frequency signal (Push-Pull)			GY	
Frequency signal (Push-Pull) and Analogue signal 4...20 mA			AY	
Frequency signal (Push-Pull) and Analogue signal 0.5...10 V			VZ	
Pulse output (Push-Pull)			DY	
Pulse output (Push-Pull) and Analogue signal 4...20 mA			IY	
Pulse output (Push-Pull) and Analogue signal 0.5...10 V			UZ	
Example order number	VMZ03BS1	PE	GY	400A



Options

Options	
For type	On request
VMZ	Frequency output Signal shape: NPN or PNP open collector Pulse output Signal shape: NPN or PNP open collector O-Ring Material: FKM

Accessories

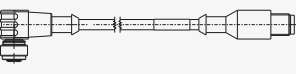

Connection cable

Order code				
Accessories		Length [m]	Length [inch]	Order number
	Connection cable with 5 pin cable socket M12 x 1, angle type moulded lead, sheathing material PUR, shielded, (Tmax = 80 °C / 176 °F), UL-approval	3 m	10 ft	XVT2053
		5 m	16 ft	XVT2009
		10 m	33 ft	XVT2070
	5 pin cable socket M12 x 1 angle type, unassembled			VT1331
	Cable adapter M12 x 1, NPN 5 pin version, angle type for adaptation to model series VMZ (until 2019)			XVMI146