

Photoelectric Sensor Solutions

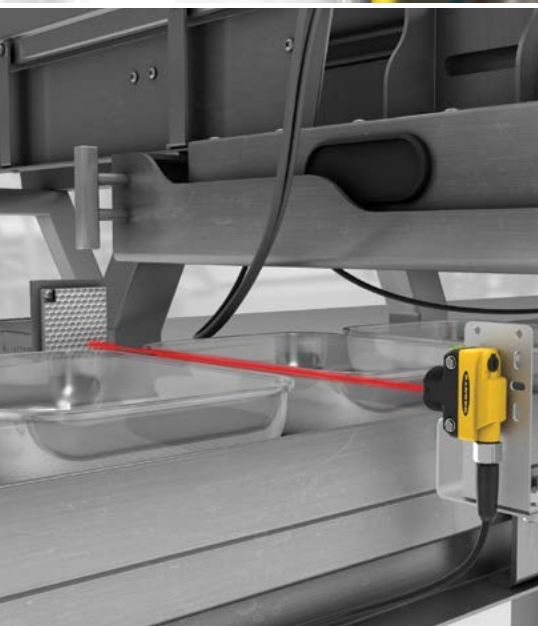

Photoelectric Sensors

Photoelectric sensors can detect the presence or absence of objects or changes in surface conditions of a target. They emit a beam of light that is detected by a receiving element. When an object interrupts or reflects the emitted light, an output switches, sending an electronic signal. Most target materials can be detected including shiny, dark, clear, or multicolored ones. Photoelectric sensors are very common in industrial manufacturing fields such as material handling, packaging, food and beverage, medical, and many others.

Photoelectric sensors can be long range, heavy duty or compact, and they are available in various detection ranges. Some require separate emitters and receivers, others include both an emitter and a receiver in one housing (with or without a reflector), and there are also sensors capable of differentiating targets from backgrounds. These various detection methods are known as sensing modes. There are many different housing and mounting options to offer a correct fit that meets the demands of each application. They perform a wide variety of tasks, can have a very fast response, and some of them can even be used in harsh environments.



Sensing Modes

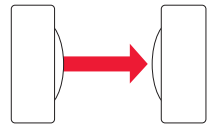

Opposed Mode

In opposed-mode sensing, the sensor's emitter and receiver are housed in two separate units. The emitter is placed opposite the receiver, so that the light beam goes directly from the emitter to the receiver. An object is detected when it "breaks" or interrupts the working part of the light beam, known as the effective beam. Depending on the application, opposed-mode sensing provides the highest reliability whenever it can be implemented. This is because light passes directly from the emitter to the receiver. Then, when an object breaks the beam, the output will switch.

- Opposed-mode sensing offers the highest level of excess gain (sensing energy)
- Long sensing range
- Most robust for harsh environments
- Precise position sensing
- Small-part detection using lens apertures
- Impervious to surface reflectivity (the color or finish of the object)

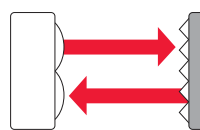

Retroreflective Mode

A retroreflective sensor contains both the emitter and receiver elements in the same housing. It uses a reflector to bounce the emitted light back to the receiver. Similar to an opposed-mode sensor, it senses objects when they interrupt or "break" the effective beam. Because retroreflective sensing is a beam-break mode, it is generally

not dependent upon the reflectivity of the object to be detected. However, it can be tricked by shiny objects, so for those targets, a polarized retroreflective sensor should be used instead to prevent proxing. Proxing is when an object with a shiny surface returns enough light to the sensor to mimic the photoelectric beam coming back from the reflector and causes the object to not be detected.

A retroreflective-mode sensor offers a convenient alternative to opposed mode when space is limited, or if electrical connections are only possible one side of the installation. Retroreflective-mode sensors offer relatively long ranges.

- Second-highest excess gain mode
- Polarized model available to prevent the beam from proxing off shiny objects
- Coaxial optics available for clear objects and precision

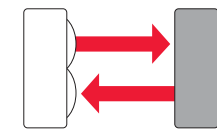

Diffuse Mode

Diffuse-mode sensors contain the emitter and receiver in the same housing but do not use a reflector. Instead, they detect an object when emitted light is reflected off a target and back to the sensor. With a diffuse-mode sensor, the object is detected when it "makes" the beam, that is, the object reflects the transmitted light energy back to the sensor.

Diffuse-mode sensors are significantly affected by the reflectivity of the target objects, which can drastically shorten their range. Diffuse-mode sensors should not be used in applications with very small parts that need to be detected, in parts-counting applications, or where a reflective background is close to the object to be sensed.

Diffuse-mode sensors are very convenient and are often used when opposed or retroreflective-mode sensors aren't practical.

- Low installation effort
- Does not require a reflector

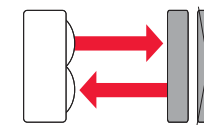

Background Suppression

Background-suppression (BGS) sensors are a diffuse-type sensor with a defined limit to their sensing range, ignoring any objects that lie beyond that range. There are two types of background-suppression sensors: fixed-field and adjustable-field. Both types

use triangulation to determine the cutoff distance which allows the sensor to ignore anything beyond that point.

The available excess gain inside the fixed sensing field is usually high, allowing sensing of less-reflective surfaces. A background-suppression sensor can often detect a dark target on a white background, if as long as the background is past the sensor's cutoff.

- Detects objects out to a set sensing distance
- Ignores background objects
- Very low color sensitivity

Excess Gain

Excess gain is a measurement of the amount of light energy that the receiver element detects. A sensor needs an excess gain of one to cause the sensor's output to switch "on" or "off." However, contaminants in the sensing environment such as dirt, dust, smoke, and moisture can cause signal attenuation, so more excess gain will be required to receive a valid signal. Excess gain may be seen as the extra sensing energy available to overcome that attenuation.

An excess gain chart shows how much light energy is available at a given distance. The dirtier the environment, the more excess gain will be needed to overcome it. The graphs are logarithmic, which allows for a concise overview of data that varies by several orders of magnitude. Each minor tick increases by a factor of 1, and each major tick increases by a factor of 10. For example, starting at the origin and moving up the Y-axis, the graph's ticks represent 1, 2, 3, etc. Once the tick gets to 10, the ticks represent 10, 20, 30, etc. When the tick gets to 100, then the ticks represent 100, 200, 300, and so on.

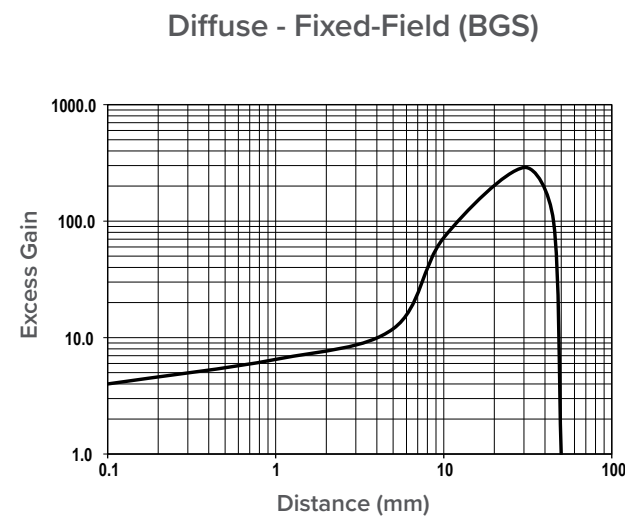
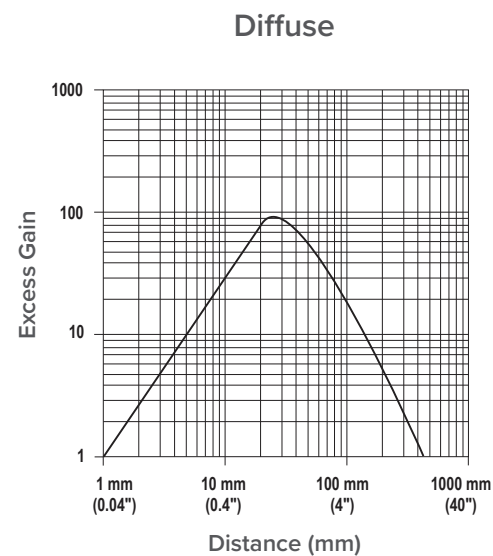
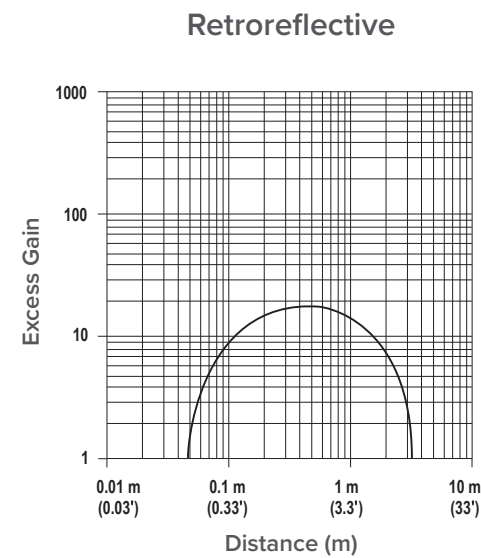
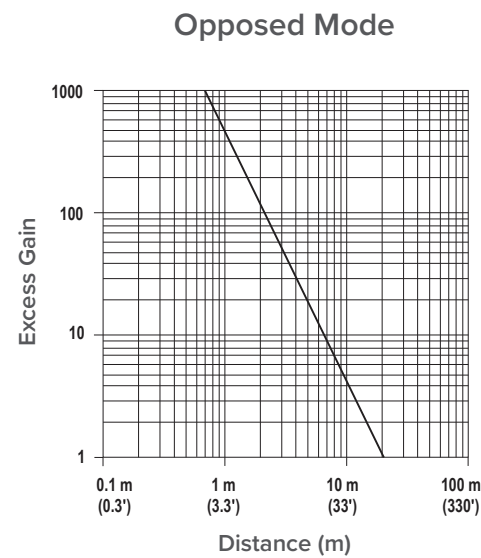

Sensing Beams

Visible LEDs

Visible LEDs help in the alignment and setup of a sensor, since the visible beam will provide a spot on the target. Red is the most common color for photoelectric sensors, because red diodes are inexpensive to make and the photodetectors in receivers are very sensitive to red light.

Materials will act differently to different wavelengths of light. A certain material may absorb one wavelength of light while reflecting another, or the contrast between two colors is low. In these cases, trying a different color LED, such as blue, can be a simple solution to the problem.

Infrared LEDs

Infrared (IR) LEDs are invisible to the human eye but are very efficient at producing light. This efficiency can help IR sensors see farther than visible LEDs. However, because the beam is invisible, it can make alignment more difficult.

Long-Wavelength Infrared LEDs

Typically, photoelectric sensors cannot see water because it is transparent to light in the visible spectrum. Fortunately, water efficiently absorbs the specific wavelength of 1450 nm, allowing for detection. Certain Banner sensors utilize long-wavelength infrared (LIR) LEDs operating at 1450 nm to detect liquids that contain water, while ignoring (burning through) clear or opaque containers.

Laser

Many Banner sensors use lasers for their emitted beams. Lasers offer the benefit of a small beam spot, longer range, and higher precision.

Beam Pattern

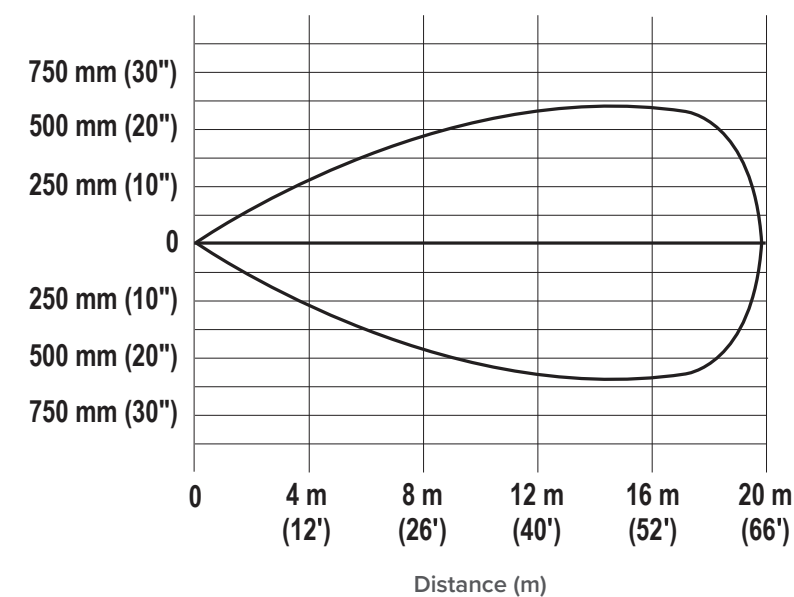

The beam pattern represents the boundary within which the sensor will respond to a target. In opposed mode, the receiver can be anywhere within this pattern and will detect light from the emitter. In retroreflective mode, the beam pattern is dependent on the reflector being used. A smaller reflector will reflect less light, which results in a shorter range and a more narrow beam pattern. In diffuse mode, the target must be within the beam pattern to be detected. In diffuse mode, the beam pattern is created using a 90% white card, so different-colored targets will affect the beam pattern.

Choosing a Banner Photoelectric Sensor

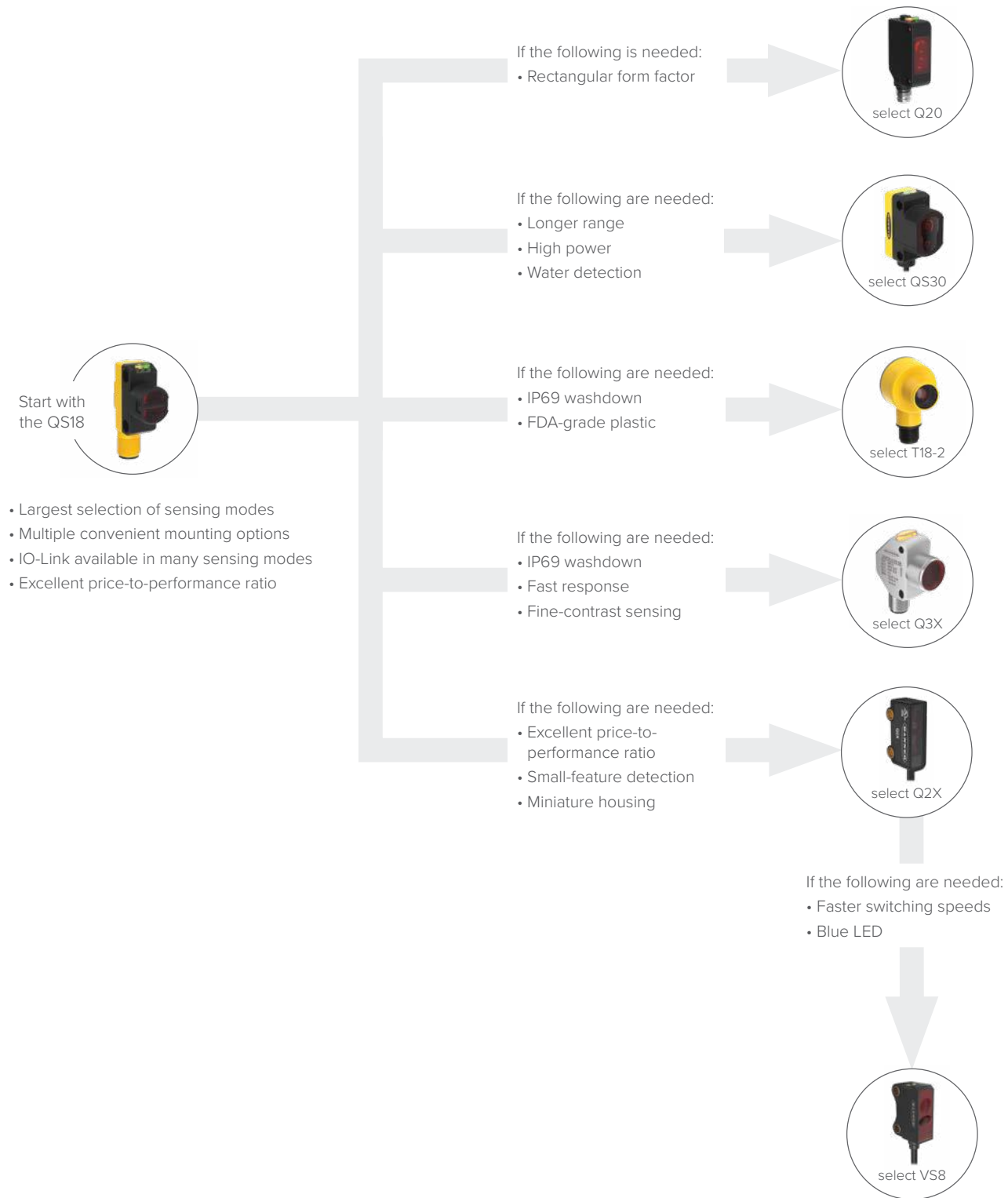

	QS18	Q20	QS30	T18-2	Q3X	Q2X	VS8
Opposed Range (m)	20	20	60	25	–	3	3
Non-polarized Retroreflective Range (m)	6.5	6	12	–	–	–	–
Polarized Retroreflective Range (m)	3.5	4	8	6	–	3.3	1.6
Laser Polarized Retroreflective Range (m)	10	–	18	–	–	–	2
Diffuse Range (mm)	600	1500	1400	750	300	–	–
Fixed-Field Range (mm)	200	150	600	200	200	75	50
Adjustable-Field Range (mm)	350	200	600	–	–	3000	70

Additional Features

	QS18	Q20	QS30	T18-2	Q3X	Q2X	VS8
Type of Emitter	LED and Laser	LED	LED and Laser	LED	Laser	LED and Laser	LED and Laser
Housing Material	Plastic	Plastic	Plastic	Plastic	Metal	Plastic	Plastic
IP Rating	IP67	IP67	IP67	IP67, IP68, IP69K	IP67, IP68, IP69K	IP67	IP67
Response Time	600–800 μs	850–1000 μs	2–5 ms	1.5–2 ms	250 μs	600 μs–100 ms	500 μs
Operating Temperature	-20 to +70 °C	-20 to +60 °C	-20 to +70 °C	-40 to +70 °C	-10 to +50 °C	-25 to +50 °C	-20 to +60 °C
IO-Link	✓	✓				✓	
Clear Object Detection	✓		✓				



QS18

All-Purpose Compact Sensor

- Rugged sealed housing, protected circuitry; available with or without 18 mm threaded “nose”
- Easily fits (or retrofits) almost any mounting situation
- Less than 1 millisecond output response for excellent sensing repeatability
- Meets IP67 and NEMA 6 standards for harsh environments
- Ranges up to 20 m
- 10 to 30 V DC operation or 20 to 140/20 to 270 AC/DC with transistor outputs
- Available in models with IO-Link communication for simplified wiring, installation, preventative maintenance, and simple sensor replacement
- Mechanical and electronic adjustable-field available
- Opposed-mode models with superior light immunity, crosstalk avoidance, and IO-Link communication



Challenge

During secondary packaging of food products, it is important that products are counted to ensure accuracy before being placed in large boxes. A reliable sensor is needed to count cartons and notify a robot after a desired number of cartons has passed on the conveyor. The robot then knows to load cartons into the box, helping to maintain an efficient manufacturing process.

Solution

Banner's QS18LLP laser sensor accurately inspects every carton that passes on the conveyor, ensuring the robot is triggered to load cartons into the package. With a visible laser sensing beam, the QS18LLP provides precise position control at a close range.

The rugged QS18LLP is also ideal for confined spaces and is easily set up along a conveyor for accurate sensing. With bright LEDs, operating status is visible from 360°. The QS18LLP has 10 to 30 V DC operation with NPN or PNP outputs, depending on the model. Installation of the QS18LLP is simple due to the mounting versatility of 18 mm threaded-barrel and side-mount options.

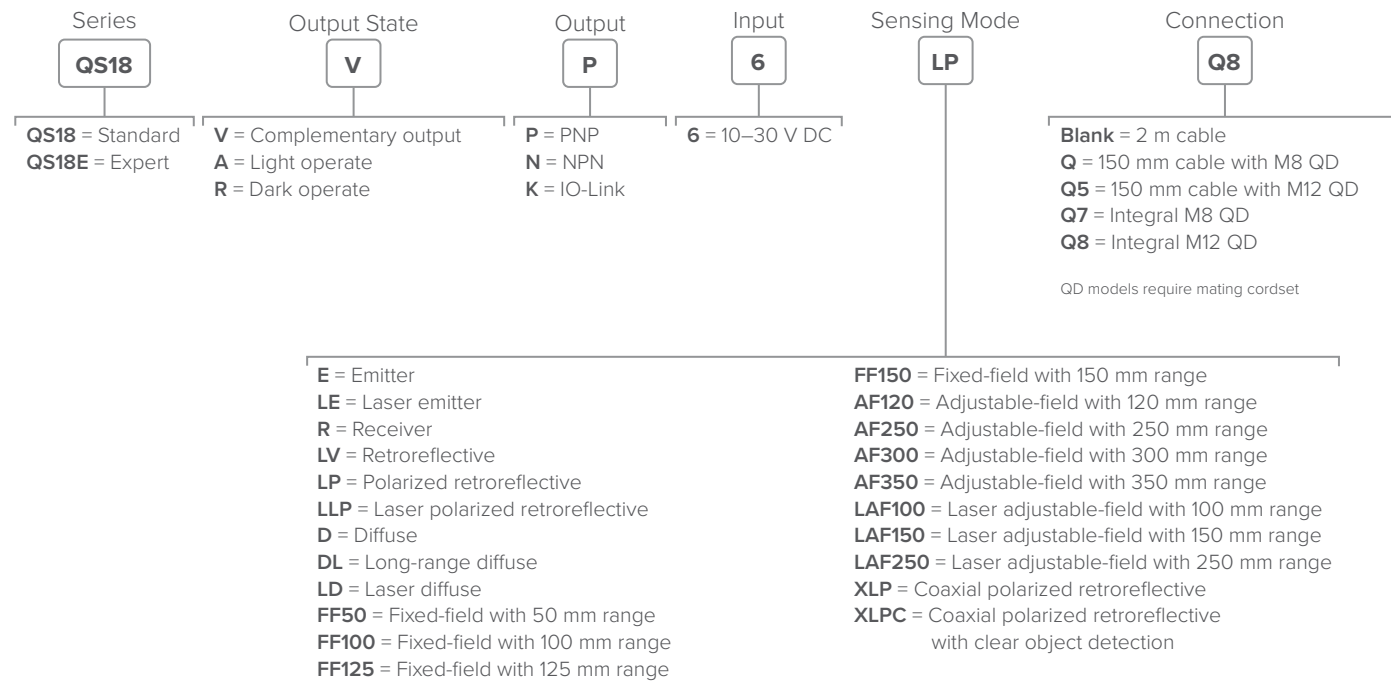

Note: Simplified model key. Not all options are shown and not all combinations are possible. Contact Banner Engineering for assistance.

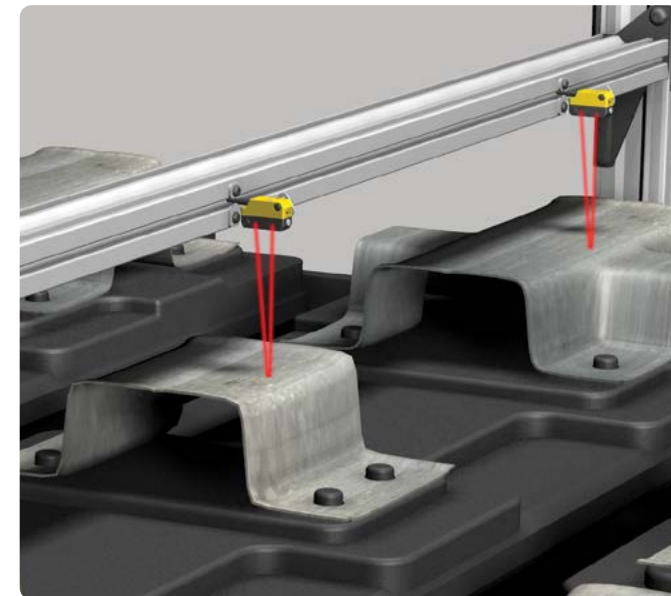

Challenge

In an automotive assembly plant, multiple parts are needed to make a subassembly, and they are commonly hand-placed together on pallets for feeding into a work station. The pallet of parts (or kit) must be verified prior to leaving the load station to ensure assembly quality and production efficiency.

The solution requires diffuse-mode sensors that will tolerate variations in part reflectivity that are inherent to the process while ignoring background light reflected off the pallet surface.

Solution

The QS18AF adjustable-field background suppression sensor is an excellent choice for this part-in-place application, requiring a three-inch scanning distance. With the combination of high-gain characteristics, sharp adjustable cutoff, and a forgiving visible red light beam, this sensor ensures longevity in this environment.



Q20 Compact Sealed Sensor

- Standard 3 mm threaded mounting holes on 25.4 mm spacing
- Advanced electronic design for excellent noise immunity and cross-talk avoidance
- 10 to 30 V DC operation with complementary solid-state outputs (1 normally open, 1 normally closed); PNP or NPN, depending on model
- Available in small-spot diffuse models for small-feature detection in error-proofing and inspection applications
- Provides water-tight, IP67- and NEMA-6-rated enclosure for rugged, reliable sensing
- Rated to 1200 psi for washdown environments

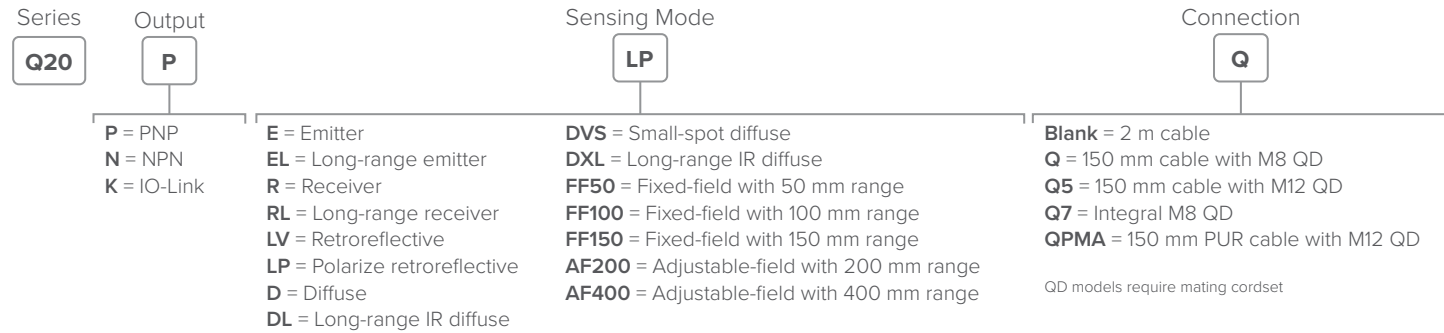

Note: Simplified model key. Not all options are shown and not all combinations are possible. Contact Banner Engineering for assistance.



Challenge

Detecting the presence of shiny or reflective objects is a challenge in many applications where a retroreflective sensor is the ideal solution due to space, cost, convenience, or other considerations. One such application is detecting unfinished aluminum beverage cans on a conveyor.

In retroreflective sensing, the sensor is looking for its emitted light returned by the retroreflector. Shiny objects can act as reflectors themselves, returning enough light to the sensor to cause the sensor to miss targets. A solution is needed that will only see the light returned from the retroreflector, and not light returned from shiny targets.

Solution

Q20 polarized retroreflective-mode sensors use polarizing filters to detect only the light returned from the retroreflector, ignoring light returned from shiny objects. Natural light is made up of waves having a variety of polarizations. Photoelectric sensors with polarizing filters emit and detect only light waves of a specific polarization while rejecting unwanted light of other polarizations.

In this application, the sensor is designed to see only the light returned from the retroreflector. When the unfinished cans pass between the sensor and the retroreflector, the light reflected off the cans has a different polarization than the light returned by the retroreflector. As a result, the beam will be blocked by the cans and the output will be triggered.



Q20-2 Compact Sensor with Precision Alignment

- Standard 3 mm threaded mounting holes on 25.4 mm spacing
- Best-in-class optical-to-mechanical alignment is up to five times more consistent than other sensors on the market
- Designed to be easy to install, align, and adjust
- Detects targets regardless of color, texture, and reflectivity up to five meters
- Provides water-tight, IP67-rated enclosure for rugged, reliable sensing

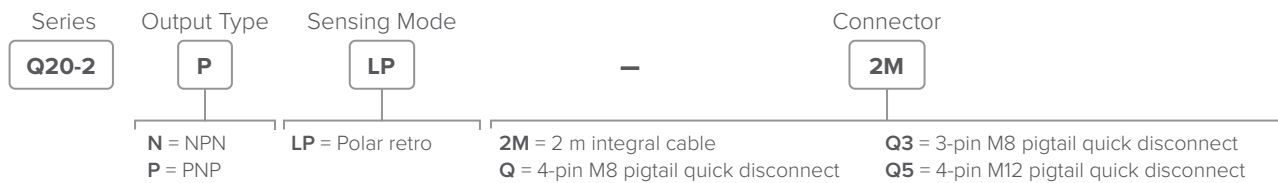

QD models require mating cordset



Challenge

An automated system applies labels to the tops of jars of food products transported through machines on a conveyor, so that they can be prepared for sale, collected together, and packaged for bulk delivery. Occasionally, jars make it all the way through the process unlabeled because the applicator device fails to pick up a label from the roll.

To improve quality and consistency, a method is needed to detect that the applicator is correctly extracting labels for placement on jar lids.

Solution

Even in applications with limited physical space, the compact but durable Q20 sensor can be installed and easily positioned to verify the presence of a label before the applicator comes in contact with the product. Because the Q20 features diffuse, one-sided sensing and a small spot size, it can be aligned to detect only the labels and not the applicator. This makes it possible for operators to quickly verify label application or determine precisely where and when labels are not being correctly transferred to products. Then the appropriate adjustments can be made to the automated systems to improve labeling results, and going forward the sensor can trigger alerts if an applicator fails to pick up a label for any reason.



QS30

High-Performance, Long-Range Sensor

- Advanced photoelectric sensor with exceptional long-range optical performance
- Compact housing with mounting versatility, via its popular 30 mm threaded barrel or side-mount holes
- Tough ABS/polycarbonate-blend housing is rated to IEC IP67, NEMA 6, or IP69K, depending on model
- Easy-to-see sensor status indicators: two status LEDs visible from 360°; extra-large output indicator
- Opposed, retroreflective, polarized retroreflective, diffuse, and fixed-field (200, 400, or 600 mm cutoff) models available
- Available in opposed, high-power opposed, polarized and non-polarized retroreflective, diffuse, laser, fixed-field, adjustable-field, and clear object sensing modes

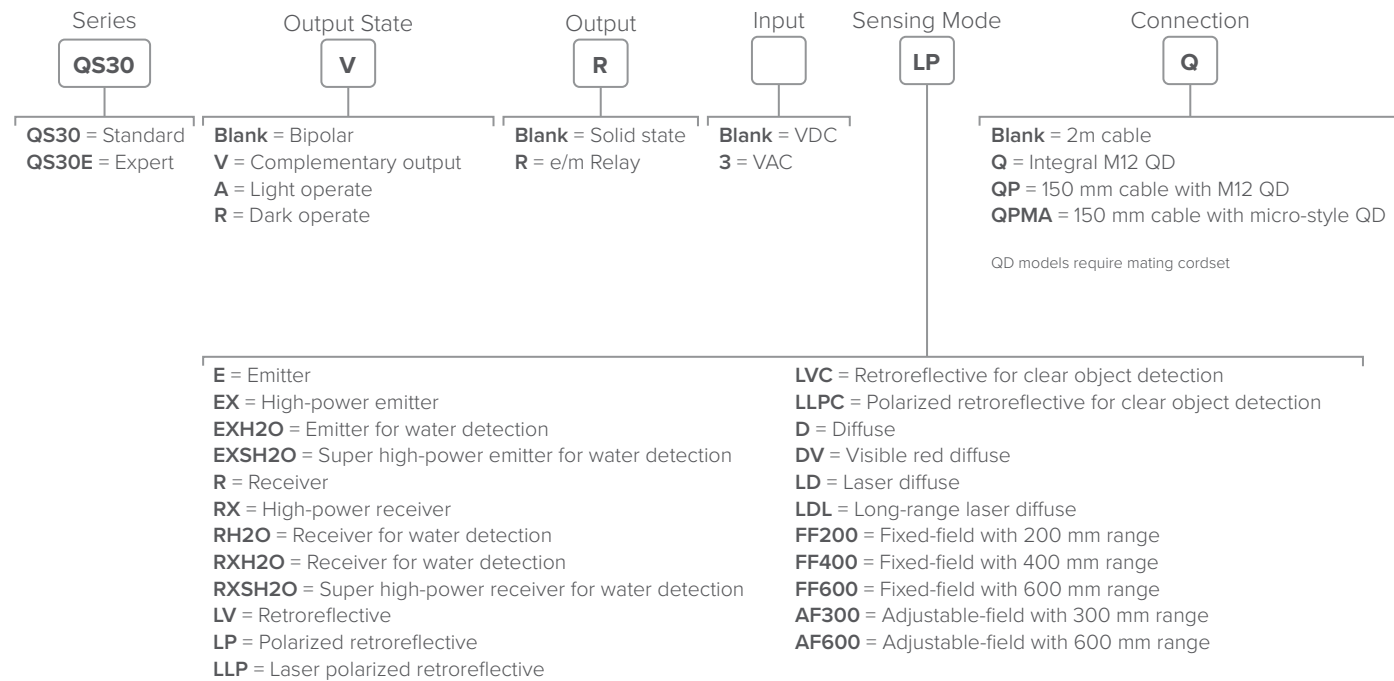

Note: Simplified model key. Not all options are shown and not all combinations are possible. Contact Banner Engineering for assistance.



Challenge

In order to maintain product consistency and customer satisfaction, liquid levels in water bottles must be verified. A sensor that can reliably detect water through a wide variety of bottles is needed in order to accurately determine fill level.

Solution

Banner's QS30H2O sensor is specially developed to address challenges with optically sensing the presence of water and water-based liquids. The QS30H2O operates in a through-beam sensing mode, and the emitter uses a wavelength that is tuned to the absorption band of water. This enhances the contrast on the application. The high excess gain of the sensor makes it powerful enough to burn through an assortment of plastic and glass containers while still being able to detect the water inside the container.

The QS30H2O works in conjunction with the QS30ELVCQ clear object sensor. The QS30ELVCQ triggers the PLC to read the QS30H2O signal. If the output is on, then the water is at or above the minimum fill level, and if the output is off, then the water level is too low and is rejected.



Challenge

Detecting vehicles in automated car washes presents many unique challenges, several due to extreme conditions. Ever-present water (sometimes at extremely high pressure), variations in temperature, the presence of sunlight, reflective surfaces, mist and steam, and the constant cycling of machine movement are factors that must be considered when using a sensor to position a vehicle correctly.

Solution

QS30EX and QS30RRX sensors are designed specifically for reliable, long-lasting performance in the extreme environments of car washes. In this application, a QS30EXQ emitter and QS30RRXQ receiver are configured in opposed mode to verify that the vehicle has passed completely through the drying stage of wash.

The sensors have an epoxy-encapsulated body, and models with quick-disconnect (QD) electrical connection fittings have IP69K-rated housings to withstand the constant presence of water and extreme temperature swings. They also have an opposed-mode range of 213 meters, using 875-nm infrared light to burn through mist and steam and provide a reliable beam-break sensing field.



T18-2

One-Piece Sensor with Long-Range Optical Performance

- IP69K epoxy encapsulated for maximum reliability in wet, thermal-shock environments
- ECOLAB™-certified FDA-grade plastic housing
- Ultrasonically welded joints for superior sealing and durability
- Improved hygienic design for easier cleaning
- Powerful and bright visible red emitter for easy alignment and setup (except for IR models)
- Laser-etched product marking will not wear off after repeated cleaning cycles
- Meets IP69 standards for harsh environments
- Ranges up to 20 m

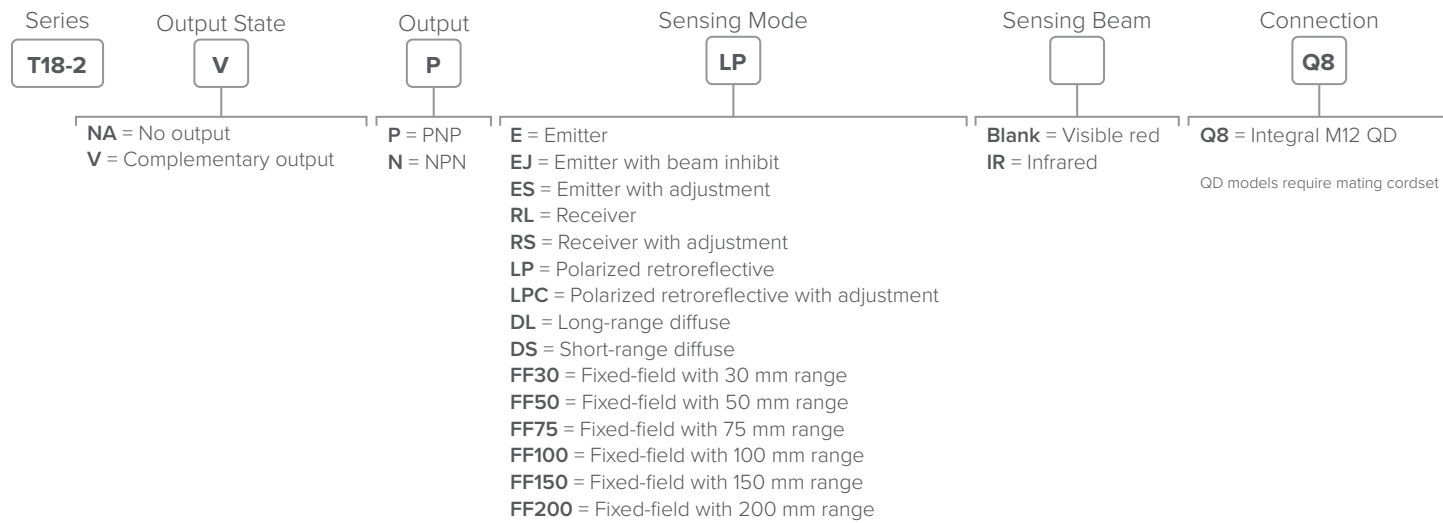

Note: Simplified model key. Not all options are shown and not all combinations are possible. Contact Banner Engineering for assistance.



Challenge

Food products move through various stages of packaging as they are prepared for delivery and display. Automation equipment and sensors must perform accurately and consistently while withstanding harsh washdown environments. Inspection on a packaged meat conveying system presents some unique challenges. In this application, meat is prepared and placed on a dark plastic tray. Before the trays are wrapped and labeled, they move along a series of white conveyor belts. In this multiple-conveyor-belt configuration, sensors must be positioned over each belt to detect the food trays as they move through the process.

Solution

The sensing characteristics of this application are simple, yet unique: the sensors are positioned directly above a white, highly reflective background and must detect darker, lower-contrast objects of varying texture. The T18-2 fixed-field sensor is an ideal solution. It has a sharp detection cutoff and is not sensitive to color variations—it will signal the presence of an object within a certain range and ignore the background. The sensor's right-angle housing allows for a low-profile machine design by keeping the cordset connections parallel with the mounting assembly. No range adjustments are needed, after the sensor is positioned over the conveyor at a height that ignores the background while detecting the food tray. QD model T18-2 sensors are rated IP69K and are designed to withstand frequent, harsh washdowns.

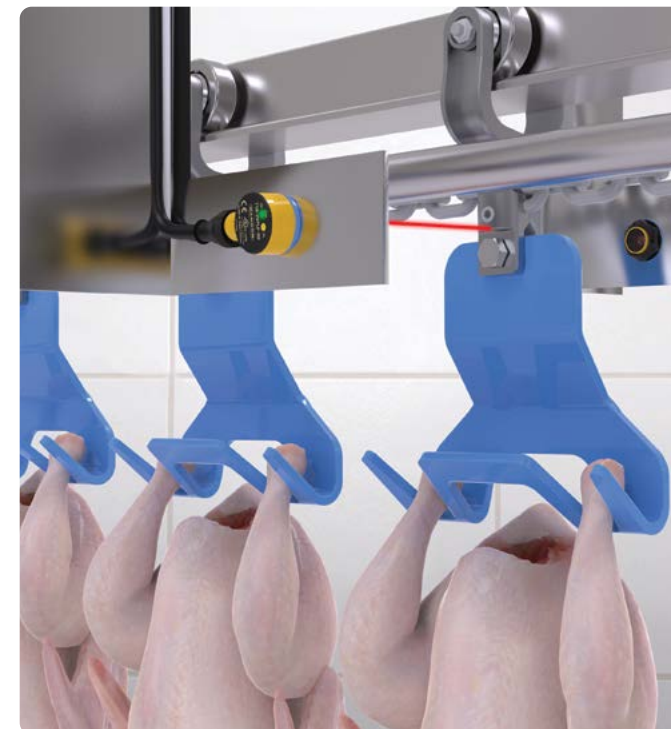

Challenge

Because animal agriculture facilities must protect customers from a variety of potential food-safety hazards, any electronic technology used in processing must support those efforts. For example, consider a poultry processing plant that requires sensors to accurately count whole-chicken meat products as they are cleaned and prepared for packaging. Naturally, this environment requires frequent washdowns to prevent bacteria and other types of contamination. Therefore, it is crucial that sensors can withstand both spray from high-pressure, high-temperature water and also caustic chemical cleaning solutions.

Solution

Banner's T18-2 Series photoelectric sensors are designed with rugged, ultrasonically welded all-plastic housings. This means that there are no plastic-to-metal joints that could expand or contract at different rates due to temperature changes. Such conditions could create small air gaps in the joints, allowing moisture into the sensor, potentially causing the sensor to malfunction or loosening sensor parts that could dislodge and fall into packaged food. Clearly, this scenario would present a physical hazard for consumers and possibly force a costly product-safety recall.

By contrast, the fully epoxy encapsulated plastic housing for a T18-2 sensor is a single piece, so there are no joints whatsoever. This thoroughly tested construction has earned it an IP69 rating to perform flawlessly in harsh environments.



Q3X Laser Contrast Sensor

- High-speed part detection as fast as 250 μ s, capturing up to 2,000 events per second
- Reliable sensing range up to 300 mm
- Used for challenging presence/absence or orientation detection for applications with small contrast differences
- Rugged, nickel-plated zinc housing suitable even for environments with cutting fluids and oils
- Clear intensity readout from angled three-digit display
- Easy setup with responsive buttons
- Fixed background-suppression models allow for contrast detection in a fixed range while ignoring a background

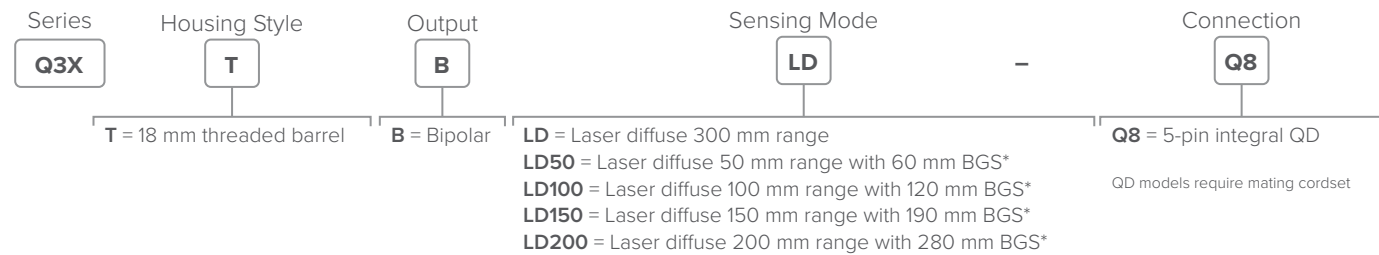

*Background Suppression

Note: Simplified model key. Not all options are shown and not all combinations are possible. Contact Banner Engineering for assistance.



Challenge

The food and beverage industry often requires verification of labels on products, including labels on bottles. The presence of reflective backgrounds is a limitation of standard diffuse-mode sensors.

Solution

Banner's versatile, rugged Q3X laser contrast sensor including background suppression is ideal for contrast applications where there is also a fixed background that needs to be ignored. In this application, the Q3X background-suppression sensor detects the contrast difference between bottles with and without a label. With a range up to 50 mm, the Q3X has a tight laser spot able to detect a small change in contrast reliably.

When the Q3X detects the tan label, the intensity readout increases and a discrete output is triggered, indicating the wine label is present. If the label is not present, the intensity readout decreases, and the output remains off. In addition, the Q3X can ignore objects greater than 60 mm away, in this case the shiny metal rail, which could be a false trigger for other sensors.



Challenge

Primary packaging has many high-speed processes, and it is important to verify correct packaging, which can be done by detecting registration marks. White registration marks on dark backgrounds, such as blue, can be challenging to detect at high speeds, since many sensors are not able to maximize contrast for reliable detection of the mark and not the background.

Solution

Banner Engineering's Q3X versatile, rugged laser contrast sensor is ideal for detecting registration marks. With a range up to 300 mm, the Q3X has a tight laser spot able to detect a small white registration mark reliably.

When the Q3X detects the white registration mark, the intensity readout increases and a discrete output is triggered, indicating the white registration mark is present and it is the correct package going down the line. The white registration mark also indicates where the packaging should be cut later in the process, so accurate and timely mark detection is critical to maintain desired package aesthetics. The rugged, nickel-plated zinc, laser-marked housing makes the sensor suitable for many environments, even where cutting fluids and oils may be present.



Q2X Miniature Sensor

- Install in space-constrained locations by leveraging a compact housing
- Precisely detect small objects using short-range models
- Detect a target across an area of over 3 meters with long-range models
- Address many challenges, by consolidating to one sensor family with the array of sensing modes available

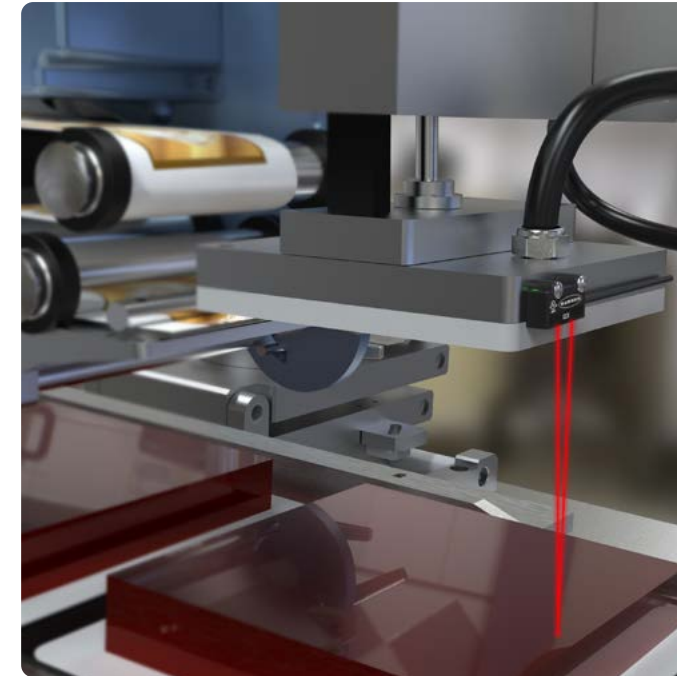

Challenge

Applying pressure-sensitive labels to packages requires lowering a tamp head to the product and applying enough pressure to adhere the label without damaging the product.

Solution

A Q2X fixed-field sensor can be fitted onto the labeling machine's tamp head to sense targets at a fixed distance, regardless of the product's color. The sharp 15 mm cutoff distance allows the tamp arm to lower to a consistent distance away from the target, even with products of differing heights. Once the tamp head is close enough to the product, it slows until it makes contact. It applies the appropriate amount of pressure to adhere the label, then rises to repeat the process.

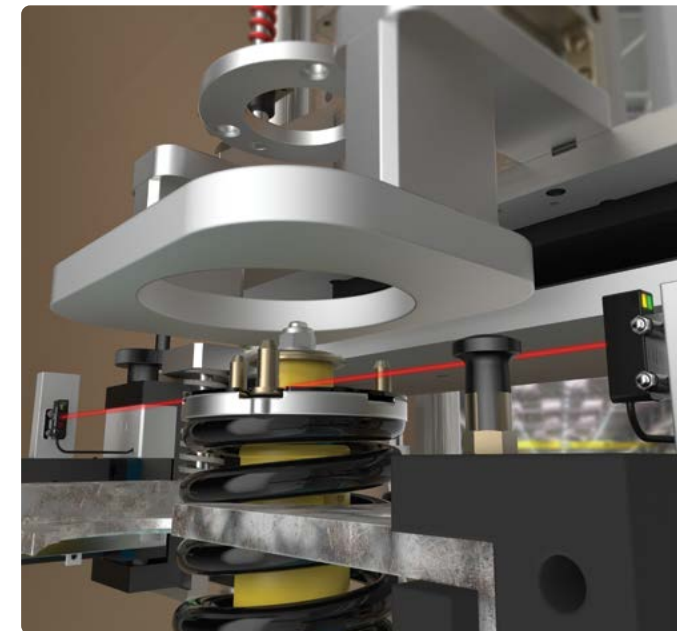

Challenge

Before a suspension strut assembly can proceed down the line, the presence of all parts must be verified. However, Tier 1 automotive assembly machines may not have enough physical space to house a larger or even average-sized sensor for this verification.

Solution

The miniature housing of the Q2X can be fit into most assembly machines. Once installed, the 4.3 mm effective beam of the Q2X means it can accurately sense whether the top cap of the strut is present; deciding if it can advance to the next stage of assembly or not.

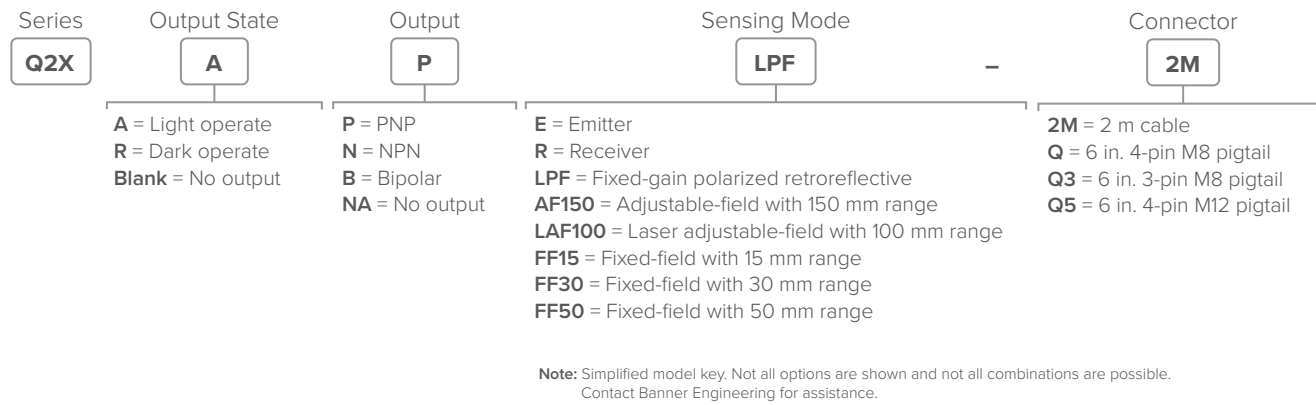



VS8

Miniature Sensor for Precise Detection

- Miniature sensor for installation in the smallest of spaces
- Precise and reliable switching behavior even with varying object surfaces and colors
- Red laser, red LED, and blue LED types are available to match the sensing beam to specific applications
- High switching frequency for detection in even the fastest processes
- User-friendly operation using electronic push button or remote input provides reliable and precise detection
- Robust, IP67 glass-fiber-reinforced plastic housing
- 10 to 30 V DC operation with solid-state outputs, PNP or NPN, depending on model
- Available in opposed, polarized retroreflective, adjustable-field, and fixed-field sensing modes



Challenge

Food-packaging OEMs are constantly facing challenges in sensing applications due to continuous changes in packaging design. In such a highly competitive market, companies are consistently vying for consumers' attention with shiny multi-colored packages that stand out in the grocery aisle. A manufacturer was having issues reliably sensing breakfast rolls packaged in dark blue and multi-color packaging. Under red LED lights, blue labels appear black and have little reflectivity, which makes detection difficult with standard red LED sensors. These sensors also experienced erratic and chattering outputs from color transitions on the label.

Solution

Banner Engineering's VS8 Miniature Photoelectric Sensor with blue LED is a unique problem-solver. The blue LED works well with low-reflectivity objects and multicolored packaging by creating more contrast for stable sensing. The VS8's small spot size minimizes the effects of color transitions as the package passes by the sensor. The blue LED with small spot size alleviated the chattering output and sensing problems and created a more reliable system for the customer.

Small sensors with shorter sensing ranges are ideal as more machine builders compress mechanical features into tight spaces. Setup is easy with remote teach, push buttons with lock-out functionality, and background suppression to ignore anything beyond the target, such as a conveyor belt.

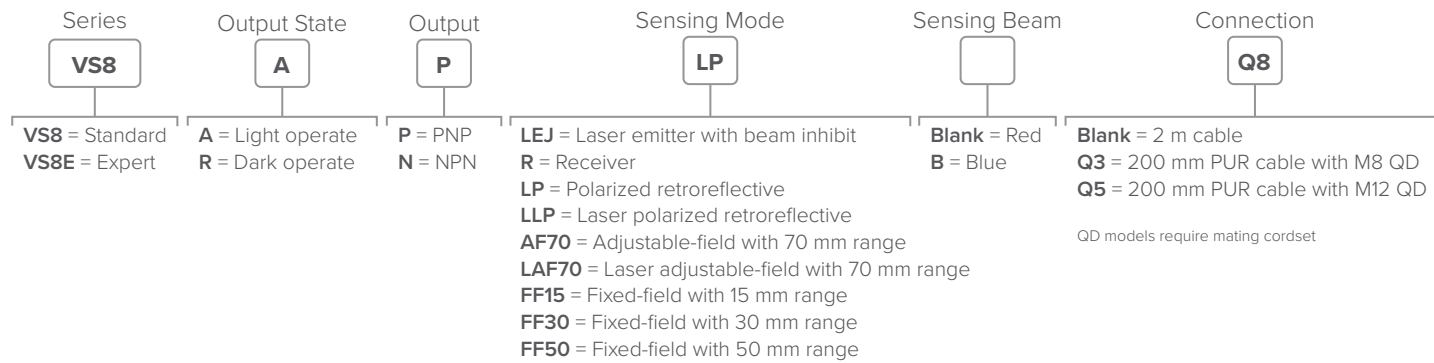

Note: Simplified model key. Not all options are shown and not all combinations are possible. Contact Banner Engineering for assistance.

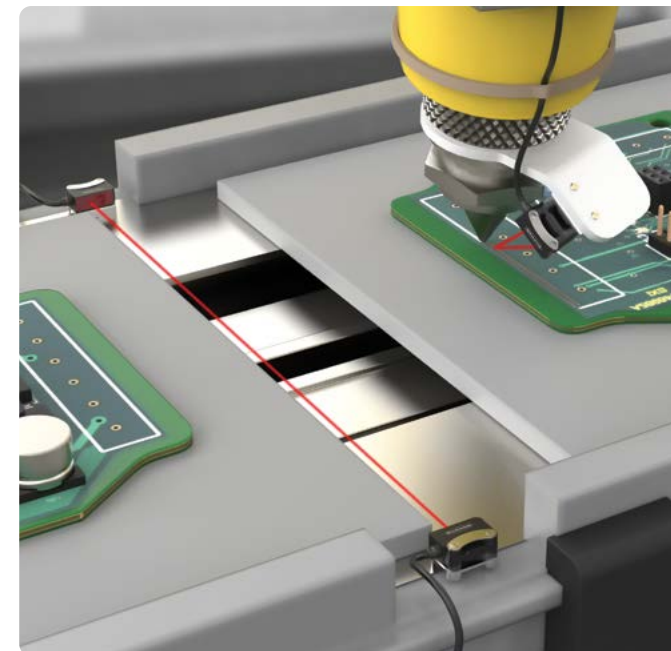

Challenge

The electronics industry designs and creates incredibly small products, and printed circuit boards (PCB) have numerous densely populated components on them. These boards are typically assembled in areas with extremely limited space. Errors on PCBs are easy to miss during manual assembly and inspections. Monitoring fill level in the glue dispenser is challenging because it is not realistic to install a sensor inside of the gun.

Solution

The VS8 sensors are positioned to aim at the boards on the line, where the robot applies the adhesive. The sensor is taught the original distance of each passing board and recognizes the very small distance change after the glue has been applied, detecting the adhesive regardless of color.

In this scenario, an operator can minimize downtime by reapplying the glue or refilling the glue gun before the part moves on to a secondary station and the glue completely dries. Poorly placed glue could easily cause PCB components to fall apart and lead to an increase in scrapped product or recalls.

A pair of VS8 miniature sensors is also installed to detect the trays that hold the printed circuit boards. As the trays move on the conveyor, the VS8 sensors detect the leading edge to confirm that they are in the correct placement for glue application. This ensures that the glue is applied to the correct areas on each PCB.

Looking for Laser Measurement Sensors?

Laser measurement sensors from Banner Engineering are ideal for use in a wide variety of discrete, analog, and IO-Link sensing applications. Our portfolio of laser sensors includes powerful problem-solving, high-precision, and long-range sensors.

Traditionally laser sensors have been used for their extended range, visible beam, small spot, and precise detection capabilities. These benefits have often been outweighed by their higher costs compared with other technologies. In recent years, pricing on components has been reduced and the technology has advanced so that the benefits of laser sensors outweigh the cost differential.

Banner laser measurement sensors have been designed to excel in harsh environments and remove common sensing barriers.



Optimized for the Most Challenging Targets

Automatic Gain Compensation and Highest Excess Gain in Class

Other sensors can be oversaturated and experience increased errors from shiny targets. Banner laser sensors automatically decrease gain to maintain accuracy.

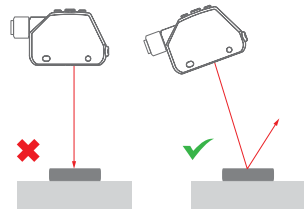
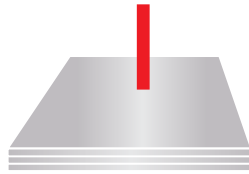

TIP: Change sensor orientation by a few degrees for more reliable detection of shiny objects

Similarly, dark objects provide a very weak signal, so our laser sensors automatically increase gain to amplify the received signal and reliably measure targets that other sensors cannot see.

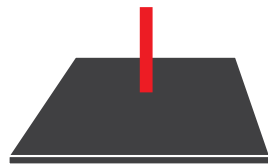

Variety of Beam Spot Sizes for Consistent Detection

A small spot minimizes measurement variation across color transitions



A small beam spot is ideal for precise profiling of small features

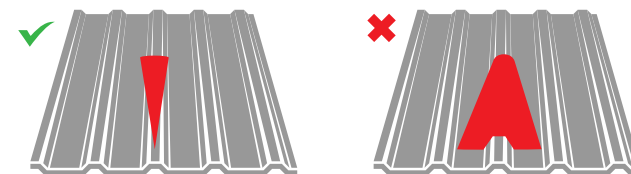

A large spot provides averaging across rough surfaces for more measurement stability



More Sensors, More Solutions.

Banner Engineering designs and manufactures industrial automation products including sensors, smart IIoT and industrial wireless technologies, LED lights and indicators, measurement devices, machine safety equipment, as well as barcode scanners and machine vision. These solutions help make many of the things we use every day, from food and medicine to cars and electronics. A high-quality, reliable Banner product is installed somewhere around the world every two seconds. Headquartered in Minneapolis since 1966, Banner is an industry leader with more than 10,000 products, operations on five continents, and a world-wide team of more than 5,500 employees and partners. Our dedication to innovation and personable service makes Banner a trusted source of smart automation technologies to customers around the globe.

