

# Safety Switches



Safety switches monitor doors, gates, and other movable physical guards that separate personnel from a hazard. They will send a signal to the machine control system if the guard has been opened, removed, or is out of position.

- Non-Contact Switches
- Hinge Switches
- Mechanical Switches
- Locking Switches

# Full Line of Door and Gate Sensing Switches



## Non-Contact Switches

- Two piece design where sensor and actuator do not contact
- In-Series Diagnostics (ISD) provides users with data from each sensor in a cascade chain
- Cascade up to 32 sensors while achieving the highest level of safety
- Accommodating to misalignment
- IP69 solutions available
- Available with the highest level of tamper resistance



## Hinge Switches

- One piece sensor and actuator with hinge function
- Fast installation and set-up with repositionable safety switch point
- Stainless steel and IP69 available
- Matching hinges without sensing available for additional door support
- Available with up to 270° safety switch point operation range



## Mechanical Switches

- Two piece design with mechanical operator feedback
- Flexible actuator options for misalignment
- Rotatable heads for flexible installation
- Mechanically coded actuators minimize tampering
- Up to 15N latching force to reduce downtime due to vibrating doors



## Locking Switches

- Two piece design with up to 2000N locking force for safety or process critical applications
- Flexible actuator option for misalignment
- Rotatable heads for flexible installation
- Mechanically coded actuators minimize tampering
- Up to 15N latching force to position door prior to locking

Sliding Guards	✓		✓	✓
Small Doors and Gates	✓	✓	✓	✓
Heavy Doors and Large Gates	✓		✓	✓
Position Monitoring (ie. tool orientation)	✓		✓	



Non-contact switch on a sliding door



Hinge switch on a door















Mechanical switch on large gate









Locking switches on large gate

# Selection Guide – Safety Switches

	NON CONTACT				HINGE	
						
	SI-MAG	SI-RF Single Door	SI-RF Cascade	SI-RF Cascade and ISD	SI-HG63	SI-HG80
Switch Technology	Magnetic	RFID	RFID	RFID	Mechanical	Mechanical
Environmental Rating	IP67	IP69	IP69	IP69	IP67 IP69 (stainless steel)	IP65
Tamper Resistance - Coding Level	Low	Low, High, Unique	Low, High, Unique	Low, High, Unique	Low	Low
Safety Rating (single sensor)	Ple/Cat 4	Ple/Cat 4	Ple/Cat 4	Ple/Cat 4	up to Ple/Cat 4*	Plc/Cat 3**
Housing	Plastic	Plastic	Plastic	Plastic	Metal	Metal
Assured On S <sub>ao</sub> / Misalignment Tolerance (mm)	3-5	10	10	10		
# of Cascaded Sensors at Ple/Cat4			32	32		
Non-Contact 	✓	✓	✓	✓		
Position Monitoring 	✓	✓	✓	✓		
LED Status Indication 		✓	✓	✓		
ISD (In-Series Diagnostics) 				✓		
Locking (1K to 2K N Force) 						
Latching (~10N Force) 						

\* Dual Switch Hinge model or applicable second safety switch added for Ple/Cat 4  
 \*\* Ple/Cat 4 achieved with applicable second safety switch added

	ROTATING HEAD	MECHANICAL			LOCKING & SENSING MECHANICAL	
						
	SI-LS31/32	SI-LS100/83	SI-QS90/75	SI-LM40	SI-LS42	SI-GL42D
	Mechanical	Mechanical	Mechanical	Mechanical	Mechanical & Solenoid Locking	Mechanical & Solenoid Locking
	IP65	IP65	IP65	IP65	IP65	IP67
	Low	Low	Low	Low	Low	Low
	Plc/Cat 3**	Plc/Cat 3**	Plc/Cat 3**	Plc/Cat 3**	Plc/Cat 3**	Plc/Cat 3**
	Plastic	Plastic	Plastic	Metal	Plastic	Head: Metal Body: Plastic
	Limit Switch models available	Limit Switch models available		Limit Switch models available		
		✓	✓	✓	✓	✓

# Non-Contact – RFID Switches

10 mm Misalignment Tolerance to avoid false trips

LEDs for status and diagnostics

IP69 housing

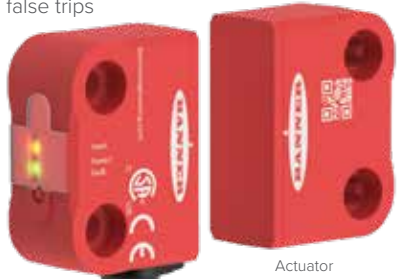

Actuator

Resistant to high vibration and operations with metallic shavings

M12 QD or 2 m cordset available



## RFID Single

- Single door RFID non-contact gate/door sensing solution
- Resistant to high vibration and operations with metallic shavings

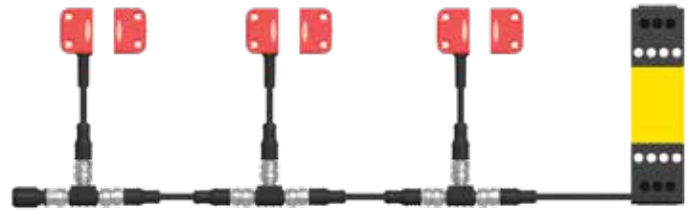

Safety Relay

## RFID Cascade

- Multiple door RFID non-contact gate/door sensing solution
- 4-pin QD connections for cost-effective, simple, error-free installation
- Resistant to high vibration and operations with metallic shavings
- Connect up to 32 sensors in series while maintaining the highest level of safety

Family	System Type	Reset	Coding*	Connector
<b>SI-RF</b>	<b>P</b>	<b>T</b>	<b>U</b>	<b>P8</b>
	P = Single S = Cascade D = Cascade with (ISD)	T = Automatic (Trip) L = Manual (Latch)	L = Low H = High U = Unique	P8 = 250 mm pigtail, M12 8-pin QD 2M = 2 m cordset** P5 = 250 mm, M12 5-pin QD**

NOTE: Actuator is required to complete a sensor solution. Ordered separately.

\* Tamper Resistant Coding  
 Low (L)—The SI-RF Safety Switch accepts any SI-RF-A actuator  
 High (H)—The SI-RF Safety Switch only accepts the last taught-in actuator, a maximum of 12 teach-in processes are possible  
 Unique (U)—The SI-RF Safety Switch only accepts the taught-in actuator, and only one teach-in process is possible

\*\* Available on single models only

QD models require mating cordset

## Actuators



SI-RF-A Standard Profile  
SI-RF-A2 Small Profile

## Connectors and Cordsets

- SI-RFA-TS**  
4 to 8 to 4-pin T-Adapter for series connecting switches
- SI-RFA-P**  
Termination plug
- SI-RFA-TK**  
8 to 4 to 8-pin T-Adapter for local reset button

**MQDEC-4xxSS**  
4-pin Male/Female M12 double-ended cable (straight to straight)

**MQDEC-4xxRS**  
4-pin Male/Female M12 double-ended cable (right-angle to straight)



**MQDC-4xx**  
4-pin female M12 to flying lead cable

**USB-USBM-1**  
1M USB configuration cable for the SI-RFA-DM1



For more accessories and specific cable lengths visit our website [www.bannerengineering.com](http://www.bannerengineering.com)



In-Series Diagnostics (ISD) makes it easy to access diagnostic data from devices in a safety system without special equipment or designated cabling. Users can troubleshoot machine safety systems, prevent system faults, and reduce equipment downtime. This innovative, next generation technology is exclusive to safety devices from Banner Engineering. For more information go to [www.bannerengineering.com/isd](http://www.bannerengineering.com/isd)

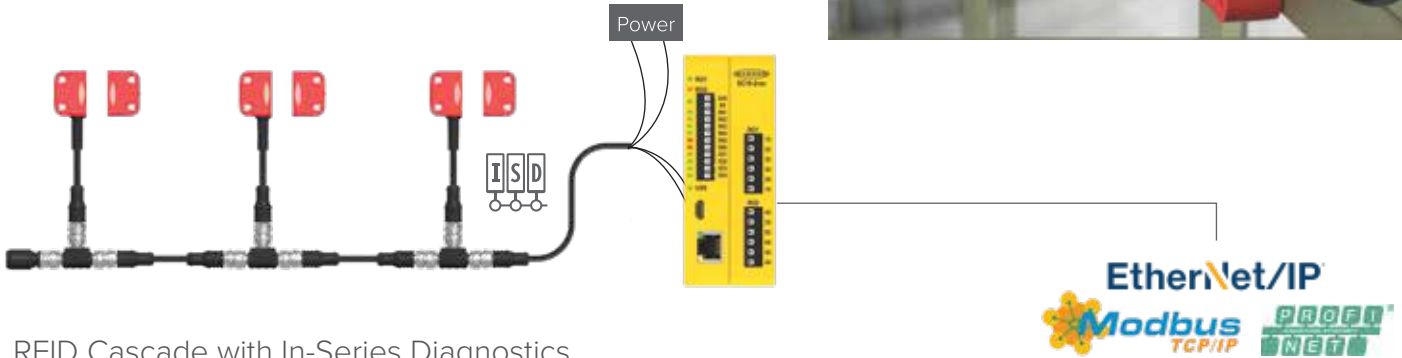

### RFID Cascade with In-Series Diagnostics

- Multiple door RFID non-contact gate/door sensing solution
- 4-pin QD connections for cost-effective, simple, error-free installation
- Resistant to high vibration and operations with metallic shavings
- Connect up to 32 sensors in series while maintaining the highest level of safety
- Door status and sensor health sent to PLC/HMI for simple trouble shooting

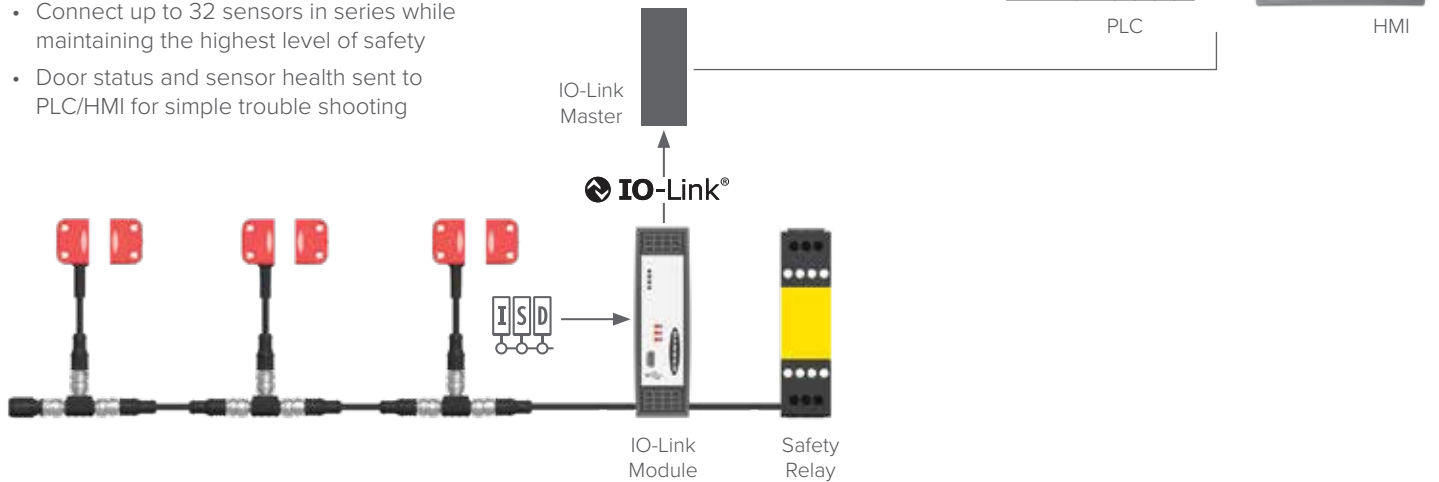

SC10-2roe

### SC10 Safety Controller

- Safety Controller and ISD to PLC Gateway
- Free and intuitive PC configuration software
- Connects up to 64 ISD devices and has 6 available safe inputs for other devices
- Two independently controlled safety relay outputs (3 NO contacts each) with 6 Amps each



SI-RFA-DM1 for panel mount



SI-RFA-DM2 IP69-rated

### ISD to IO-Link Module

- ISD to IO-Link Gateway
- Connect up to 32 ISD inputs
- Easily daisy-chain to a Safety Relay or Safety Controller

# Non-Contact – Magnetic Switches

- Cost-effective non contact solution minimizes device wear and tear, even in applications with persistent use
- 3 to 5 mm misalignment tolerance
- A single magnetic pair can achieve up to Category 4/PLe safety rating
- Coded magnets minimize the potential for intentional defeat
- Available in cable or QD models

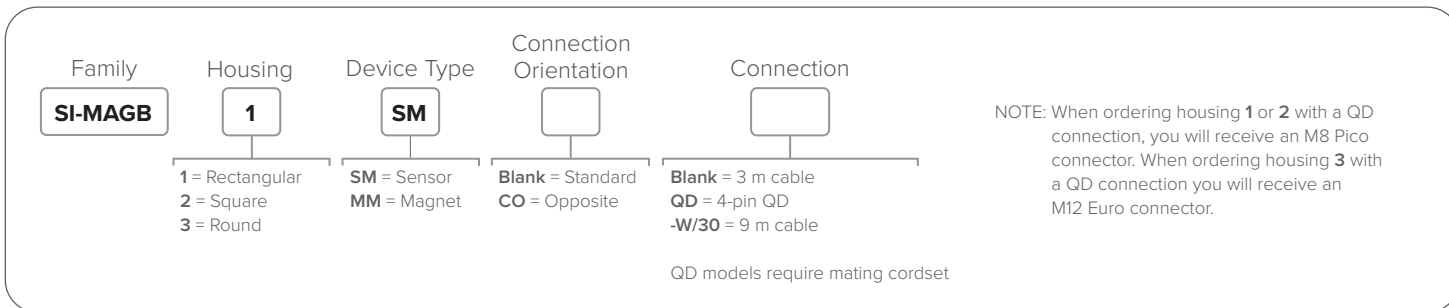

SI-MAGB1..



SI-MAGB2..



SI-MAGB3..



# Hinge Switches

- Mounts at the axis of a swinging guard where the possibility of misalignment is at its lowest, minimizing the opportunity for nuisance trips
- Achieves Category 4/PLe safety rating with two switches deployed
- Once set, the switch point setting mechanism is fully concealed within the switch, preventing access and complicating any attempts to bypass safety functions
- Available in stainless steel, IP69-rated models that resist high-pressure, high-temperature washdown and similar challenges
- Hinge switches are similar in appearance to standard door hinges, making them completely inconspicuous once installed; also available without an added switch for extra support
- One piece device installs quickly with no need to align the switch and actuator

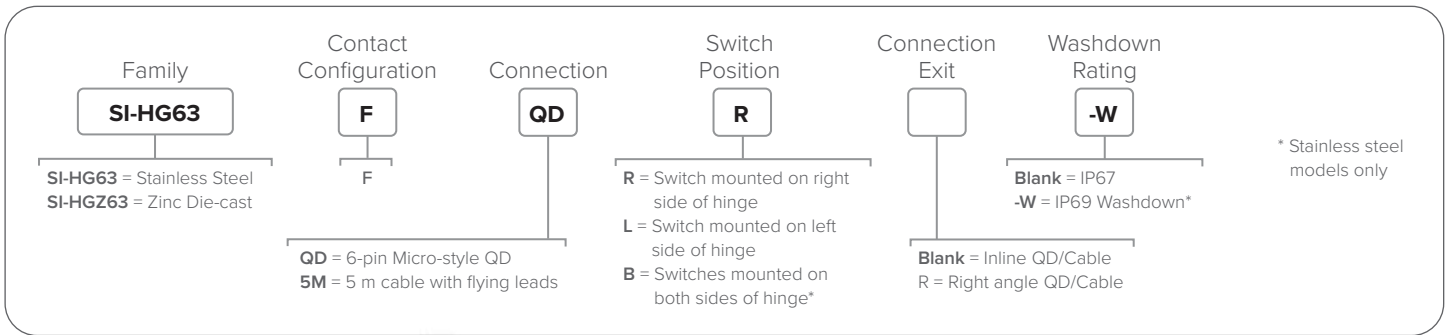

SI-HG63 stainless steel models shown



A 270° range of motion ensures that movable guards can be opened when the hazard is in a safe state without interfering with the movement of personnel or equipment outside the protected area.



SI-HG80DQD  
Inline QD Fitting

SI-HG80DQDR  
Right-angle QD Fitting

SI-HG80A  
Blank Hinge

SI-LS31HG  
Lever Hinge Switch

SI-LS3R  
Rotary Hinge Switch

SI-HG63A  
Blank Hinge

# Mechanical Switches

- Mechanical safety interlock switches consist of an actuator mounted to a movable machine guard aligned with a switch mounted to the machine. The actuator must be inserted into the switch for the machine to operate.
- Mechanically coded actuators use two independent operating elements, making it difficult to bypass safety functions
- A machine guard door will not easily open if the actuator is properly embedded into the switch, minimizing nuisance trips caused by machine vibration
- Operators can feel when the actuator has been fully inserted into the switch, ensuring that the guard has been properly closed
- Achieves Category 4/PLe safety rating with two switches deployed on a guard
- IP65-rated safety devices that resist dust, dirt, and some exposure to water and similar environmental challenges

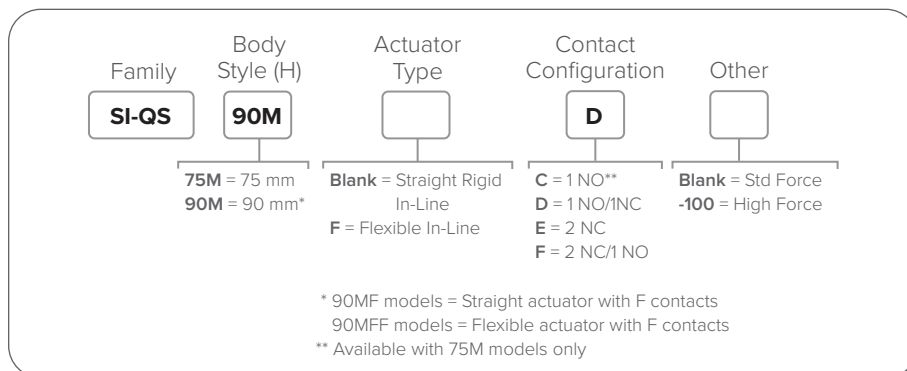
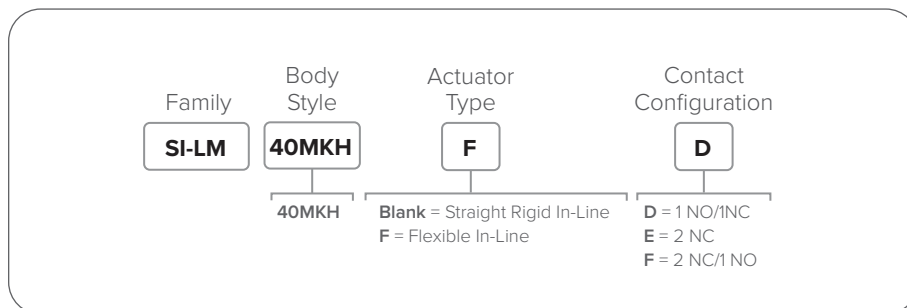
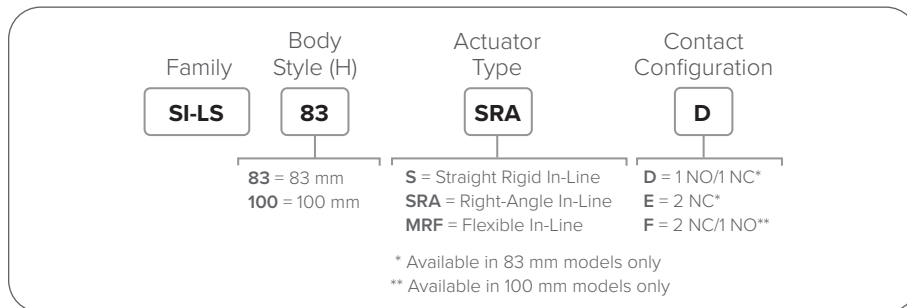

## Limit Switches

- Cost effective one piece sensor
- No actuator allows for fewer alignment issues
- Hideable making them more tamper-resistant
- Mechanically coded actuators use two independent operating elements to minimize intentional tampering or defeat
- Rotating head and top or side engagement allows for eight different actuator positions
- Design meets positive opening requirements for safety switches



# Locking Switches

- Locking safety switches include a machine mounted switch and a guard mounted actuator that prevent access to an area by remaining locked together until the hazardous motion has come to a complete stop.
- Rotating head requires little or no tools to adjust to one of four positions allowing for flexible positioning
- Can be used to prevent access to a hazard, ensure critical processes are not interrupted, or secure material and equipment from theft or tampering
- Mechanically coded actuators use two independent operating elements, making it difficult to bypass safety functions
- Once locked, a machine guard door will not open, eliminating an opportunity for nuisance trips, even if exposed to frequent impact or prolonged vibration
- Operators can feel when the switch and actuator have locked, ensuring that the guard has been properly closed
- IP67-rated safety devices that resist dust, dirt, and some exposure to water and similar environmental challenge

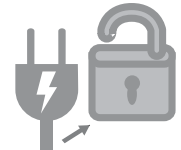
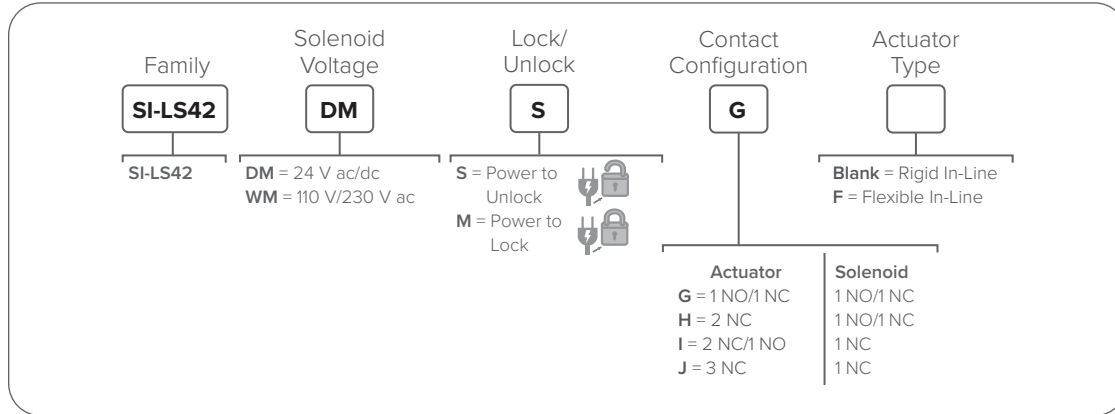

Power to unlock

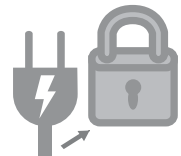

Power to lock

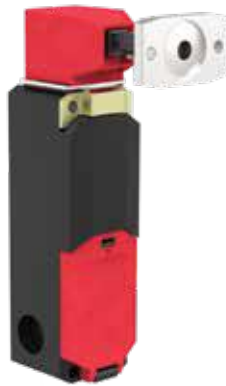

SI-LS42..



SI-LS42 with an optional K30L indicator



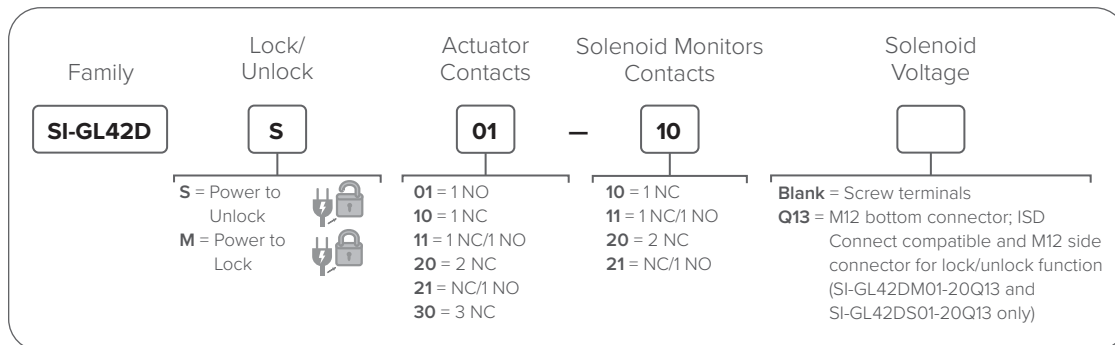













Model	Color
SI-K30LGRX7P	Green, Red
SI-K30LRX7P	Red



SI-GL42D..

# Selecting Controllers and Safety Relays

Industrial safety controllers and relays provide an interface between safety devices and the machines and processes those devices monitor for a complete and easy-to-use safety control solution.

						
Series	XS26	SC26	SC10	ES	UM	GM
# of Input Terminals	up to 154*	26	10*	1	1	1
Independently Controlled Safe Outputs	up to 68*	4	2	1	1	1
Max.Safety Output Rating	0.5A, 6A* ea.	0.5A ea.	6A ea.	7A	7A	6A
In-Series Diagnostics (ISD) 			✓			
ON/OFF Delay 	✓	✓	✓			
PCCC  Modbus  PROFINET  EtherNet/IP	✓	✓	✓			
RFID 	✓	✓	✓		✓	
Magnetic Switches 	✓	✓	✓			✓
Hinge Switches 	✓	✓	✓	✓	✓	
Mechanical Switches 	✓	✓	✓	✓	✓	
Limit Switches 	✓	✓	✓	✓	✓	
Locking Switches 	✓	✓	✓	✓	✓	

NOTE: Up to Cat. 4 PL e. per EN ISO 13849-1; SIL 3 per IEC 61508 and IEC 62061. See [www.bannerengineering.com](http://www.bannerengineering.com) for additional information.

\* Expandable input and output modules available