

## Instruction Manual

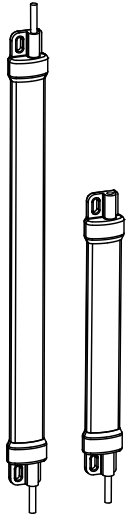

Banner's WLS15 LED Strip Lights have sturdy aluminum inner frames, encased in shatter resistant, UV-stabilized, polycarbonate shells, making them ideal for indoor and outdoor applications.

- Low-profile, space-saving design
- Rugged, water-resistant design
- Available in six lengths from 220 mm to 1200 mm
- Daisy chain power to multiple lights
- Optional snap clips for easy installation and repositioning
- Capability to dim lights using PWM input
- Operates on 12 V dc or 24 V dc in one model
- Patent pending

These Work Light Strips are available as either stand-alone models, or as cascade models that can be "daisy-chained" together for longer lighting runs, with a minimum of wiring.

Stand-alone models have one end for power connection and no connections at opposite end. A stand-alone model may be used as the last in the cascade series.

Cascade models have one end for power connection, and a connection at the opposite end for connecting to other lights in the cascade. A double-ended accessory cordset may be used between each pair of lights in a cascade to extend the distance between lights.



For PWM dimming, use with the LC65P2T 2-wire dimmer module. For more information, refer to the LC65 LED Dimmer Module datasheet, p/n 177086.

## Models

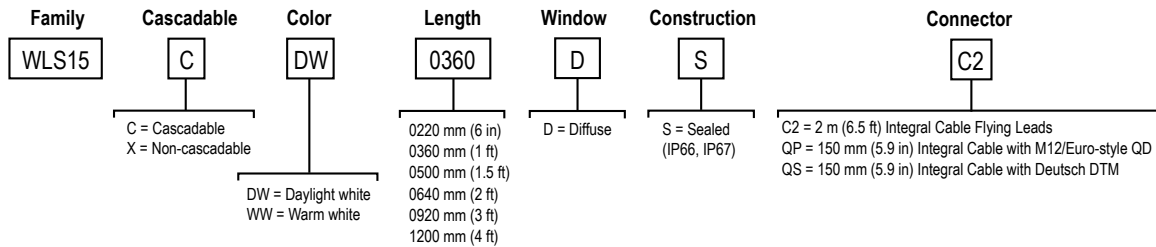

## Wiring Diagrams

QP Models				
Male	Female	Pin	Wire Color	Connection
		1	brown	12 V dc or 24 V dc
		3	blue	dc common
		4	black	Not used
		2	white	Not used

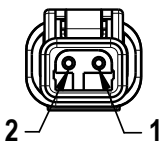
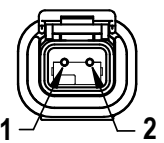

OS Models				
Male	Female	Pin	Wire Color	Connection
		1	brown	12 V dc or 24 V dc
		2	blue	dc common

## Specifications

### Supply Voltage

12 V dc or 24 V dc nominal  
 Absolute operational limits of 10 V dc to 15 V dc and 20 V dc to 27 V dc  
 Use only with a suitable Class 2 power supply (UL) or a SELV power supply (CE)  
 Light can be PWM dimmed between 25% to 100% with a frequency up to 1000 Hz

### Supply Protection Circuitry

Protected against reverse polarity and transient voltages

### Construction

Clear anodized aluminum housing; Polycarbonate outer housing, Polyamide end caps

### Test Data

LM-70, LM-80, TM-21

### Supply Current and Lumen Output

Light Length	Typical Current (A) at 25° C <sup>†</sup>		Maximum Current (A) at -40° C		Lumens <sup>†</sup>	
	12 V dc	24 V dc	12 V dc	24 V dc	Daylight White	Warm White
0220 mm	0.19	0.10	0.24	0.12	175	170
0360 mm	0.38	0.20	0.48	0.24	350	340
0500 mm	0.57	0.30	0.72	0.36	525	510
0640 mm	0.76	0.40	0.96	0.48	700	680
0920 mm	1.14	0.60	1.44	0.72	1050	1020
1200 mm	1.52	0.80	1.92	0.96	1400	1360

### Environmental Rating

Rated IEC IP66 and IEC IP67  
 Suitable for Wet Locations per UL 2108

### Operating Temperature

-40 °C to +60 °C (-40 °F to +140 °F)

### Storage Temperature

-40 °C to +70 °C (-40 °F to +158 °F)

### Light Characteristics

Daylight white color temperature (CCT): 5000K (±300K)  
 Warm white color temperature (CCT): 3000K (±200K, -100K)  
 CRI: 80 minimum

### Spacing Criterion

Vertical: 1.26  
 Horizontal: 1.26

### LED Lifetime

Lumen Maintenance - L<sub>70</sub>  
 When operating within specifications, output will decrease less than 30% after 50,000 hours.

### Application Note

When connecting cascable lights in series, it is important not to exceed maximum current limitations:

- Maximum length of light at 12 V dc: 2.4 m (7.9 ft)
- Maximum length of light at 24 V dc: 6 m (19.7 ft)

### Mounting

Integral mounting slots for M4 (#8) screws, tighten to 5 in-lbf max torque  
 Multiple bracket options available  
 Secure cables within 150 mm (5.9 inches) of the light

### Connections

2 m (6.5 ft) integral cable, 150 mm (5.9 in) integral 4-Pin M/12 Euro-style quick disconnect cable, or 150 mm (5.9 in) 2-pin Deutsch DTM series sealed cable; models with a quick disconnect or Deutsch DTM connector require a mating cordset



Note: Do not spray cable with high-pressure sprayer, or cable damage will result.

### Vibration and Mechanical Shock

Vibration 10 Hz to 55 Hz 1.0 mm p-p amplitude per IEC 60068-2-6  
 Shock 15G 11 ms duration, half sine wave per IEC 60068-2-27

### Certifications



Patent pending



UL Recognized for easy installation in control cabinets.

<sup>†</sup> Values shown at 25 °C - current and lumen values decrease 0.3% per 1 °C from ambient. For example, a 1200 mm unit will have a maximum current of 1.92 A at -40 °C and 1.38 A at +70 °C.

## Dimensions

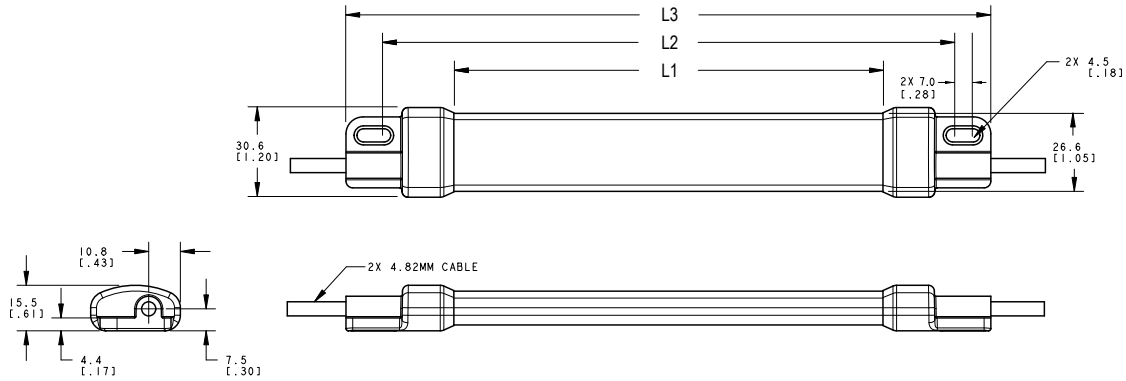

Models	L1	L2	L3
WLS15..0220..	146.4 mm (5.76 inches)	194 mm (7.64 inches)	220 mm (8.66 inches)
WLS15..0360..	286.4 mm (11.28 inches)	334 mm (13.15 inches)	360 mm (14.17 inches)
WLS15..0500..	426.4 mm (16.79 inches)	474 mm (18.66 inches)	500 mm (19.69 inches)
WLS15..0640..	566.4 mm (22.3 inches)	614 mm (24.17 inches)	640 mm (25.2 inches)
WLS15..0920..	846.4 mm (33.32 inches)	894 mm (35.2 inches)	920 mm (36.22 inches)
WLS15..1200..	1126.4 mm (44.35 inches)	1174 mm (46.22 inches)	1200 mm (47.24 inches)

## Light Characteristics — Daylight White

### 220 mm Models

**Polar Candela Distribution**

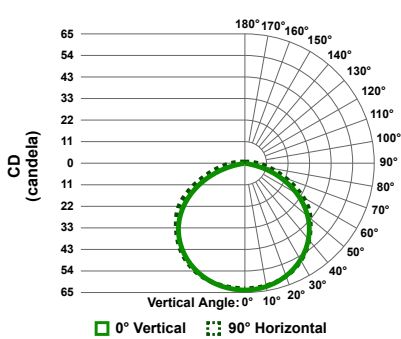

**Isolux Pattern**

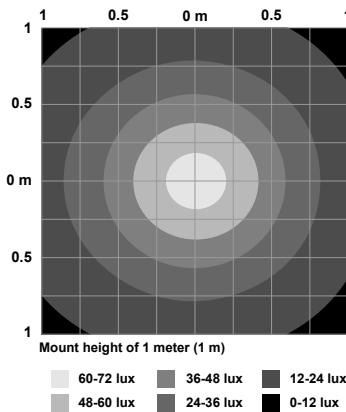

**Illuminance at a Distance**

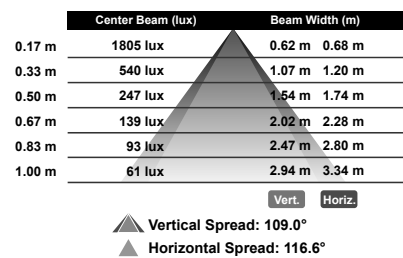

360 mm Models

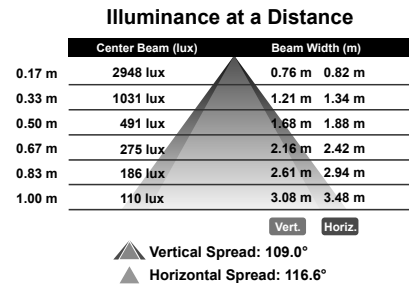
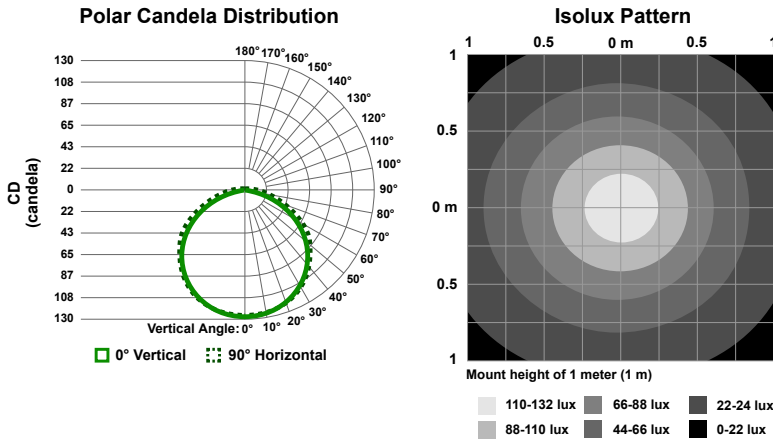

500 mm Models

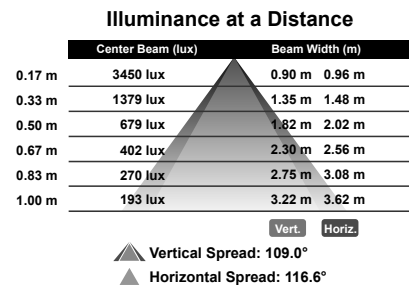
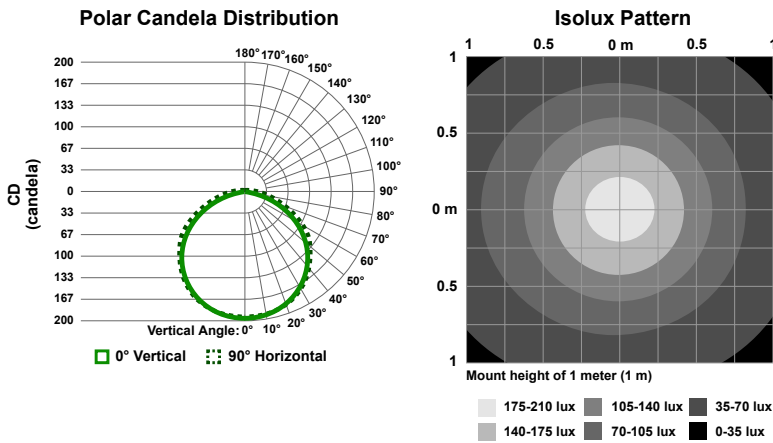

640 mm Models

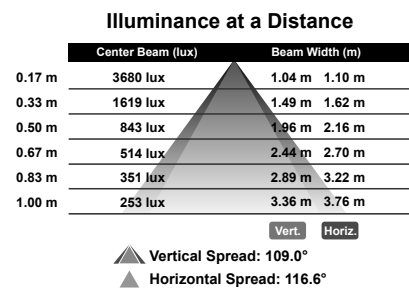
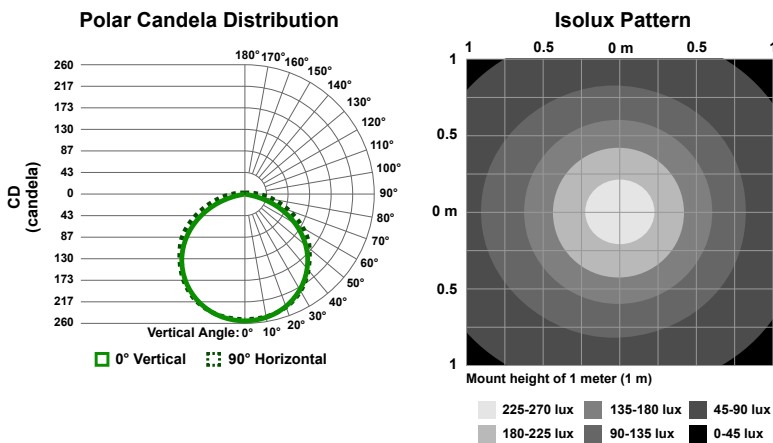

920 mm Models

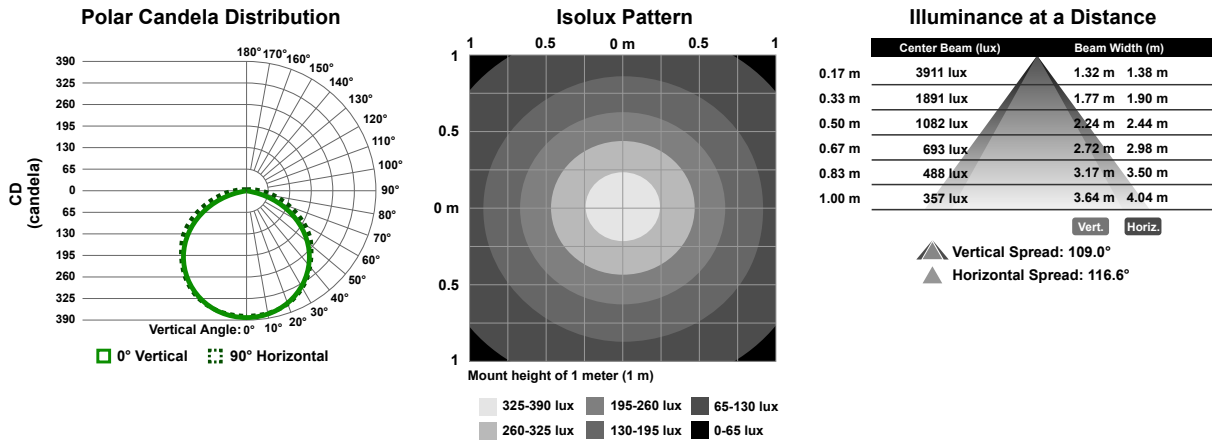

1200 mm Models

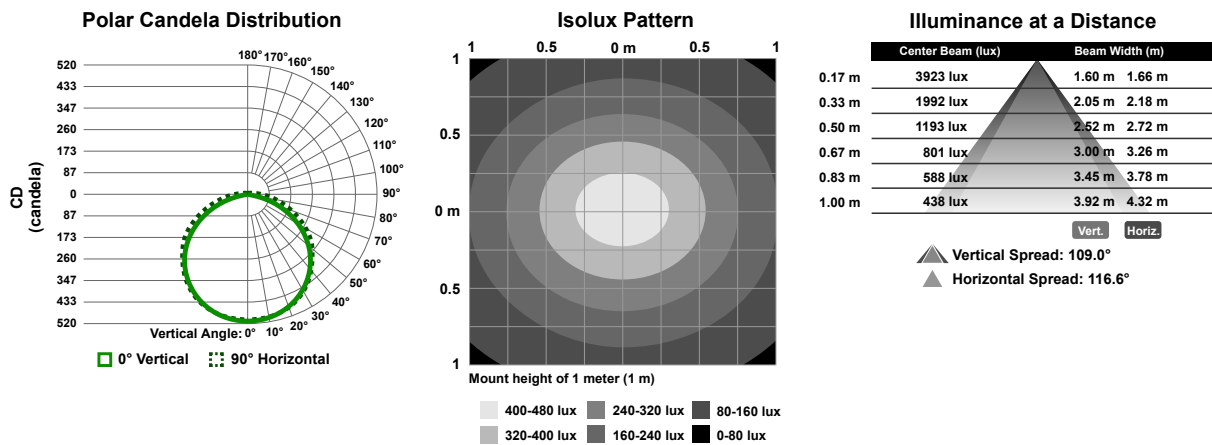

Accessories

Cordsets

Use single-ended cordsets between the power source and the QD connection of a stand-alone light or the first light in a cascade. Use double-ended cordsets between lights in a cascade.

4-Pin Threaded M12/Euro-Style Cordsets				
Model	Length	Style	Dimensions	Pinout (Female)
MQDC-406	1.83 m (6 ft)	Straight		
MQDC-415	4.57 m (15 ft)			
MQDC-430	9.14 m (30 ft)			
MQDC-450	15.2 m (50 ft)			

1 = Brown  
2 = White  
3 = Blue  
4 = Black

4-Pin Threaded M12/Euro-Style Cordsets				
Model	Length	Style	Dimensions	Pinout (Female)
MQDC-406RA	1.83 m (6 ft)	Right-Angle		
MQDC-415RA	4.57 m (15 ft)			
MQDC-430RA	9.14 m (30 ft)			
MQDC-450RA	15.2 m (50 ft)			

4-Pin Threaded M12/Euro-Style Cordsets—Double Ended				
Model	Length	Style	Dimensions	Pinout
MQDEC-401SS	0.31 m (1 ft)	Male Straight/ Female Straight		Female
MQDEC-403SS	0.91 m (3 ft)			
MQDEC-406SS	1.83 m (6 ft)			Male
MQDEC-412SS	3.66 m (12 ft)			
MQDEC-420SS	6.10 m (20 ft)			
MQDEC-430SS	9.14 m (30 ft)			
MQDEC-450SS	15.2 m (50 ft)			1 = Brown 2 = White 3 = Blue 4 = Black

2-Pin Deutsch Cordset—Single Ended				
Model	Length	Style	Dimensions	Pinout
DTMC-206	1.83 m (6 ft)	Straight		Male
DTMC-215	4.57 m (15 ft)			
DTMC-230	9.14 m (30 ft)			Female
				1 = Brown 2 = Blue

2-Pin Deutsch Cordset—Double Ended				
Model	Length	Style	Dimensions	Pinout
DTMEC-2005	0.16 m (0.5 ft)	Straight		Male
DTMEC-201	0.31 m (1. ft)			
DTMEC-203	0.91 m (3 ft)			Female
DTMEC-206	1.83 m (6 ft)			
DTMEC-212	3.66 m (12 ft)			
DTMEC-220	6.10 m (20 ft)			
DTMEC-230	9.14 m (30 ft)			

1 = Brown  
2 = Blue

4-Pin Threaded M12/Euro-Style <b>Splitter</b> Cordsets—Flat Junction			
Model	Branches (Female)	Trunk (Male)	Pinout
CSB-M1240M1240	No branch	No trunk	<p>Female</p> <p>Male</p> <p>1 = Brown 2 = White 3 = Blue 4 = Black</p>
CSB-M1240M1241	2 x 0.30 m (1 ft)	No trunk	
CSB-M1241M1241		0.30 m (1 ft)	
CSB-M1248M1241		2.50 m (8 ft)	
CSB-M12415M1241		4.57 m (15 ft)	
CSB-M12425M1241		7.60 m (25 ft)	
CSB-UNT425M1241		7.60 m (25 ft) Underterminated	

## Mounting Accessories

### LMBWLS15

- Stainless steel clip bracket
- Includes 3 clip brackets and 2 plastic spacers
- Clearance hole for M5 hardware

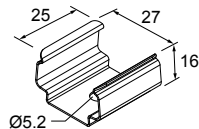

### LMBWLS15-150S

- Set of 2 stainless steel swivel bracket, allows for 150° of movement
- Clearance hole for M5 button head screw

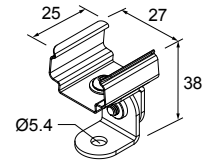

## LMBWLS15MAG

- Set of 2 brackets
- Magnetic mounting bracket for attachment to steel and iron surfaces

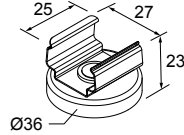

## LMBWLS15TD

- Includes 4 100 mm (4 in) strips of 3M™ Dual Lock™ reclosable fasteners
- Recommended for mounting to metal and plastic surfaces
- Strong, pressure-sensitive adhesive bonds on contact



## LMBWLS15TF

- Includes 2 100 mm (4 in) strips of double-sided foam urethane strips
- Acrylic adhesive provides high bond strength to most surfaces
- Bonds to low surface energy plastics such as polypropylene and powder coated paints



All measurements are listed in millimeters [inches], unless noted otherwise.

## Power Supplies

## PSD-24-4

- 90-264 V AC 50/60 Hz input
- Includes a 1.8 m (6 ft) US style 5-15P input plug
- 24 V DC UL Listed Class 2 M12/Euro-style connector output
- 4 Amps total current



## Banner Engineering Corp. Limited Warranty

Banner Engineering Corp. warrants its products to be free from defects in material and workmanship for one year following the date of shipment. Banner Engineering Corp. will repair or replace, free of charge, any product of its manufacture which, at the time it is returned to the factory, is found to have been defective during the warranty period. This warranty does not cover damage or liability for misuse, abuse, or the improper application or installation of the Banner product.

THIS LIMITED WARRANTY IS EXCLUSIVE AND IN LIEU OF ALL OTHER WARRANTIES WHETHER EXPRESS OR IMPLIED (INCLUDING, WITHOUT LIMITATION, ANY WARRANTY OF MERCHANTABILITY OR FITNESS FOR A PARTICULAR PURPOSE), AND WHETHER ARISING UNDER COURSE OF PERFORMANCE, COURSE OF DEALING OR TRADE USAGE.

This Warranty is exclusive and limited to repair or, at the discretion of Banner Engineering Corp., replacement. IN NO EVENT SHALL BANNER ENGINEERING CORP. BE LIABLE TO BUYER OR ANY OTHER PERSON OR ENTITY FOR ANY EXTRA COSTS, EXPENSES, LOSSES, LOSS OF PROFITS, OR ANY INCIDENTAL, CONSEQUENTIAL OR SPECIAL DAMAGES RESULTING FROM ANY PRODUCT DEFECT OR FROM THE USE OR INABILITY TO USE THE PRODUCT, WHETHER ARISING IN CONTRACT OR WARRANTY, STATUTE, TORT, STRICT LIABILITY, NEGLIGENCE, OR OTHERWISE.

Banner Engineering Corp. reserves the right to change, modify or improve the design of the product without assuming any obligations or liabilities relating to any product previously manufactured by Banner Engineering Corp. Any misuse, abuse, or improper application or installation of this product or use of the product for personal protection applications when the product is identified as not intended for such purposes will void the product warranty. Any modifications to this product without prior express approval by Banner Engineering Corp will void the product warranties. All specifications published in this document are subject to change; Banner reserves the right to modify product specifications or update documentation at any time. Specifications and product information in English supersede that which is provided in any other language. For the most recent version of any documentation, refer to:

[www.bannerengineering.com](http://www.bannerengineering.com).